

# Body-Solid

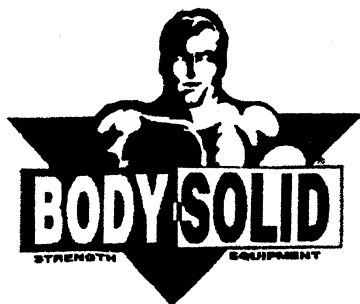
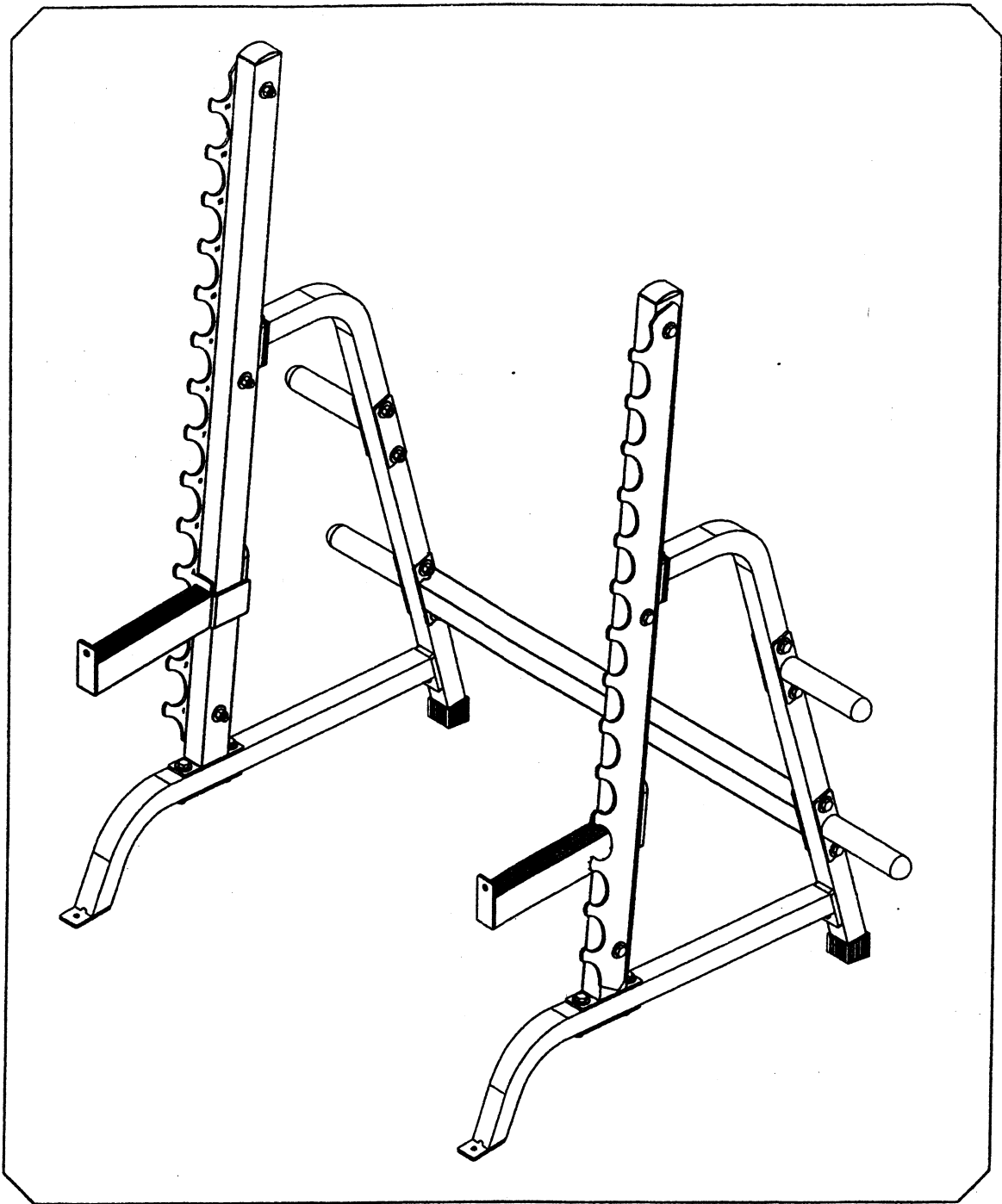

BODY-SOLID, Inc.  
1900 S. Des Plaines Ave.  
Forest Park, IL 60130 USA  
Phone: (708) 427-3555  
Fax: (708) 427-3556  
[www.bodysolid.com](http://www.bodysolid.com)

**GPR-370 OWNER'S MANUAL**

# **GPR370 ASSEMBLY INSTRUCTIONS**

## **TABLE OF CONTENTS**

<b>General Instructions .....</b>	<b>2</b>
<b>Training Tips and Safety Information .....</b>	<b>3</b>
<b>Inspection and Maintenance Schedule .....</b>	<b>4</b>
<b>Hardware Illustration .....</b>	<b>5-6</b>
<b>Parts Illustration .....</b>	<b>7</b>
<b>Assembly (Step 1) .....</b>	<b>8-9</b>



## GENERAL INSTRUCTIONS

Thank you for purchasing the Body-Solid equipment. At Body-solid, our goal is to ensure customer satisfaction. If you have any questions about these instructions or have any problems with assembly or parts for this machine, please call our Customer Service Department at 1-800-556-3113.

Prior to assembling any Body-Solid machine, please take the time to read the instructions thoroughly. Please use this manual to make sure that all parts have been included with your shipment. When ordering replacement parts, please refer to the part number and description of each part from this manual. Use only Body-Solid replacement parts when servicing any Body-Solid machine. Failure to do so may void your warranty and could result in personal injury.

Body-Solid equipment is designed to provide the safest, smoothest and most effective workouts possible. After you have finished assembling this product, check all stations to ensure correct operation. If for some reason you experience problems with any functions of this machine, do not continue operation. First, re-check all of the assembly instructions to locate any possible errors made during assembly. If you are not able to correct the problem, contact our Customer Service Department immediately at 1-800-556-3113.

## TOOLS REQUIRED

- Socket Wrench
  - 1/2" Sockets
- Crescent Wrench
- Rubber Mallet
- Tape Measure

# **GPR370 ASSEMBLY INSTRUCTIONS**

## **TRAINING TIPS AND SAFETY INFORMATION**

**Before starting any exercise program, it is recommended that you consult your physician and get a complete physical examination. There is a risk assumed by individuals who use this type of equipment. To minimize risk, follow the rules below.**

- Always consult your physician before starting any exercise program.
- Do not allow children or minors to play on or around the equipment.
- Warm up properly before engaging in any weight training regimen.
- Before using, read all the warning labels and instructions on the use of this machine.
- Do not modify the machine in any way.
- Inspect the machine before use for any damaged, worn or missing parts. If there is any doubt about the ability of this equipment to operate safely, do not use the equipment until it is serviced.
- Exercise with care, performing exercises at a smooth, moderate pace. Never perform jerky or uncoordinated movements that may result in injury.
- Never hold your breath while exercising.
- Learn how to perform the exercise correctly before using heavy weight. Correct form is important to avoid injury and to ensure that you work the proper muscle groups.
- It is recommended that you train with a training partner.
- Keep body and clothing clear of cables and moving parts when the machine is in use.
- Know your limitations. If you are new to resistance training or are starting an exercise routine after a prolonged lay-off, start slowly and build up to a more intense routine.

**Failure to follow these rules may result in serious injury. If unsure about the proper use of the machine, consult your local Body-Solid distributor or call the Body-Solid Customer Service department at 1-800-556-3113.**

# GPR370 ASSEMBLY INSTRUCTIONS

## INSPECTIONS AND MAINTENANCE SCHEDULE

There is a risk assumed by individuals who use this type of equipment. To minimize risk, follow the rules below.

- Inspect equipment daily, ensuring that all nuts, bolts and screws are fully tightened.
- Inspect cables daily ensuring they are routed properly and not worn, frayed or stretched. Check and adjust tension on cables daily.
- When using pop-pin adjustments, always make sure the plunger for the pop-pin is securely inserted into an adjustment hole.
- Before performing any exercise, always make sure all ball-pins, ring-pins, pop-pins and selector pins are inserted properly and all snap-links are properly closed.
- Replace worn parts immediately.
- Human perspiration is corrosive. Clean your machine regularly. Wipe down and dry upholstery and frame pieces on a daily basis.
- Every week clean the chrome guide rods with a dry cloth and apply a coat of dry silicon spray or Teflon based spray lubricant.
- Every week clean and lubricate all non-chrome guide rods and all seat posts and adjustments for starting positions.
- Every week check hand grips, rollers and non-skid surfaces for wear.
- Only use Body-Solid parts. Parts from other manufacturers or any other modifications will void the warranty and may result in serious injury.
- Do not use this machine with damaged, worn or missing parts.
- If there is any doubt about the ability of this equipment to operate safely, do not use the equipment until it is serviced.
- Please ensure that all warning stickers are visible and acknowledged by users of the equipment.

**Failure to follow these rules may result in serious injury. If unsure about the proper use of the machine, consult your local Body-Solid distributor or call the Body-Solid Customer Service department at 1-800-556-3113.**

## HARDWARE ILLUSTRATION

A1. HEX BOLT 1/2"X1" PARTIAL THREAD QTY.2

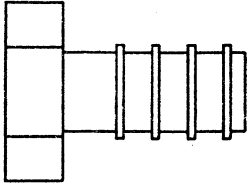

A2. HEX BOLT 1/2"X2 3/4" PARTIAL THREAD QTY.4

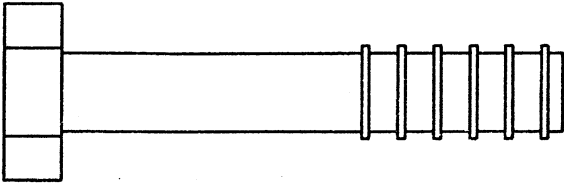

A3. HEX BOLT 1/2"X3 1/4" PARTIAL THREAD QTY.18

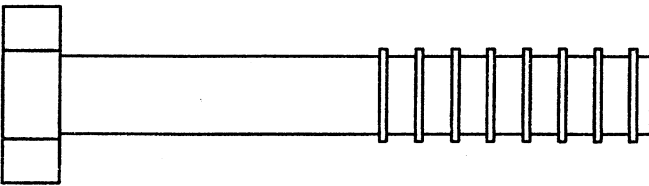

B1. NYLON LOCK NUT 1/2" QTY.18



C1. 1/2" (I.D) FLAT WASHER (O.D)Q34 QTY.40

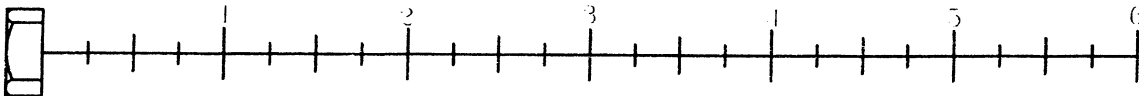
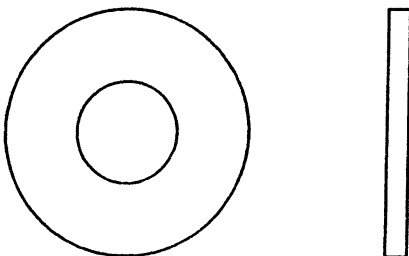

## HARDWARE ILLUSTRATION

- D1. 50X75 END CAP (9211-084) ----- [2PCS]
- D2. 38X325 RUBBER BAR CATCH (9310-042) ----- [2PCS]
- D3. 2"X2" FOOT CAP (9212-018) ----- [2PCS]
- D4. Q49.5 RUBBER END CAP (9211-074) ----- [4PCS]
- D5. 45X45 TAPE (9440-067) ----- [4PCS]
- D6. 45X70 TAPE (9440-068) ----- [2PCS]

D1

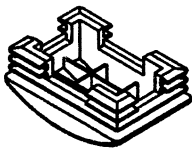

D2

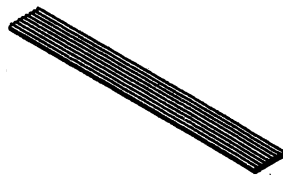

D3

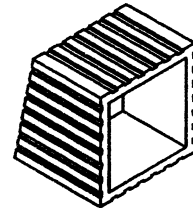

D4

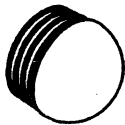

D5



D6

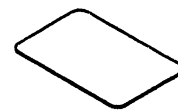

# GPR370 ASSEMBLY INSTRUCTIONS

## PARTS ILLUSTRATION SHEET

A [2PCS]

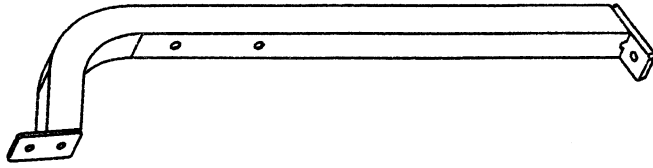

E [1PCS]

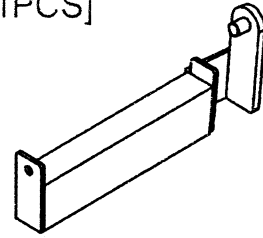

B [2PCS]

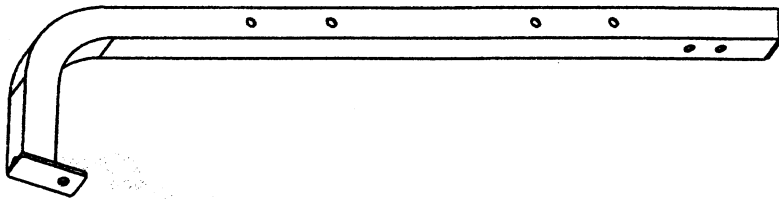

F [1PCS]

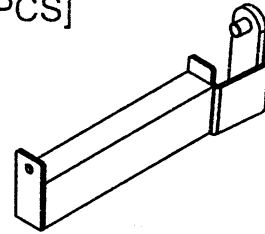

C [2PCS]

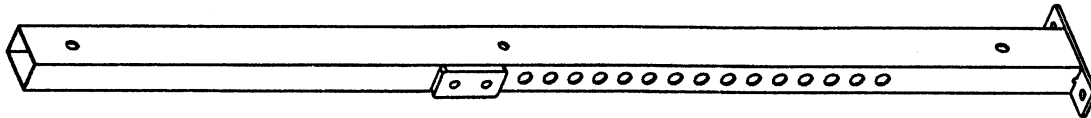

D [1PCS]

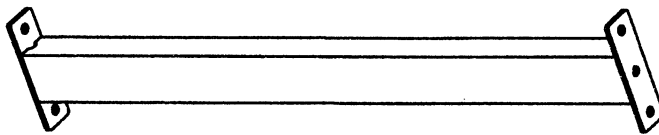

G [4PCS]

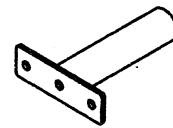

H [4PCS]

(8312-091)



I [1PCS]

(8343-056)

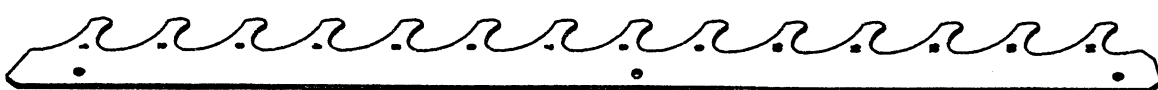

J [1PCS]

(8343-056)

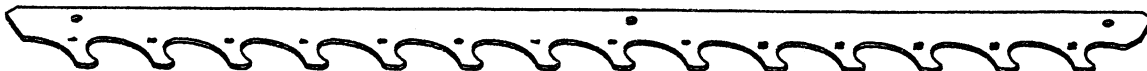



# GPR370 ASSEMBLY INSTRUCTIONS

## ASSEMBLY- STEP 1

*\*\*Note : Do Not fully tighten frame bolts and nuts until after completing Step 1*

The following Parts and Hardware will be needed to complete Step 1

Parts Description			Hardware Description		
<u>Qty</u>	<u>Part</u>	<u>Part Description</u>	<u>Qty</u>	<u>Part</u>	<u>Part Description</u>
2	A	Base Frame	2	A1	1/2"x1" hex head bolt
2	B	Side Frame	4	A2	1/2"x2 3/4" hex head bolt
2	C	Upright Frame	18	A3	1/2"x3 1/4" hex head bolt
1	D	Cross Support	18	B1	1/2" Nylon Lock Nut
2	E	Left Safety	40	C1	1/2" (I.D) Washer
1	F	Right Safety	2	D1	50x75 End Cap
4	G	Weight Horns	2	D2	38x325 Rubber Bar Catch
4	H	Support Plates	2	D3	2"x2" Foot Cap
1	I	Lift Off Frame	4	D4	Ø49.5 Round End Cap
1	J	Lift Off Frame	4	D5	45x45 Tape
			2	D6	45x70 Tape

### Step by Step

1. Attach 2 (A) - Base Frame to 2 (B) - Side Frames
2. Attach (D) - Cross Support and 2 (G) - Weight Horns to 2 (B) - Side Frame
3. Attach (A) - Back Frame and (J) - Back Support Plate to (B) - Middle Frame
4. Attach 2 (G) - Weight Horns and 2 (H) - Support Plates to 2 (B) - Side Frames
5. Attach (I) - Lift Off Frame and (J) - Lift Off Frame to 2 (C) - Upright Frames

**\*\*Securely Tighten All Frame Bolts Used in Steps 1**

# GPR370 ASSEMBLY INSTRUCTIONS

## ASSEMBLY STEP 1

THERE IS A RISK ASSUMED BY INDIVIDUALS WHO USE THIS TYPE OF EQUIPMENT. TO MINIMIZE RISK, YOU MUST FOLLOW THESE RULES:

1. Inspect equipment before each workout. Check that all nuts, bolts, screws and pop pins are in place and fully tightened. Also, before use, check cables for signs of wear. Replace all worn parts immediately. Never use machine if any parts are damaged or missing. Failure to follow these rules may result in serious injury.
2. Keep clear of the cables and all moving parts when the machine is in use.
3. Always make sure all Snap Links are closed when doing any cable/pulley exercises.
4. Exercise with care. Perform your exercises at a smooth moderate pace; never perform jerky or uncoordinated movements that may cause injury.
5. It is recommended that you should workout with a training partner.
6. Do not allow children or minors to play on or around this equipment.
7. If unsure of proper use of equipment, call your local Body-Solid distributor or the Body-Solid customer service department at 1-800-556-3113.
8. **WARNING:** Consult your physician before starting your exercise program. For your own safety, do not begin any exercise program without proper instruction.

RAL2-11-98

