

A50 FULL BODY AIR-MASSAGE CHAIR
OPERATION INSTRUCTIONS

SAVE THESE INSTRUCTIONS

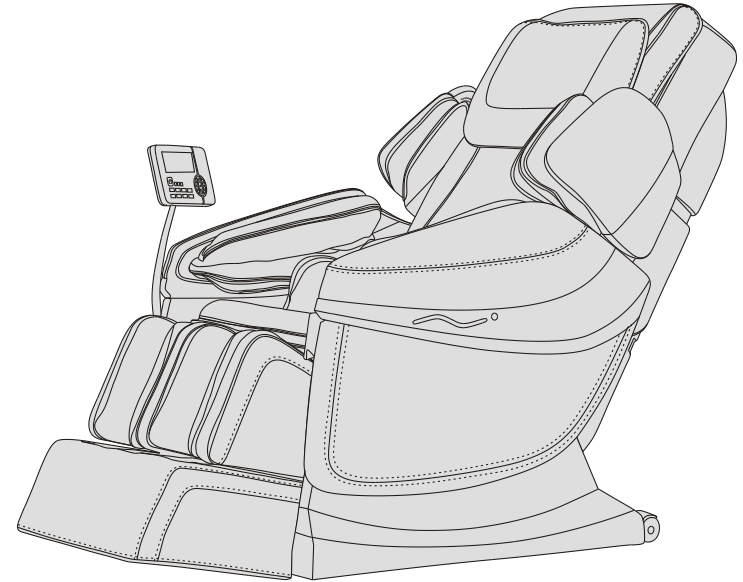

Thanks for purchasing this product. Please read this manual instruction carefully in order to know how to use this product correctly before operation. Please pay more attention to some important safety warning and keep this manual book properly for future use.

Note: Our Company reserves the right to revise the design and description of this product without any further notice. Please refer to the actual color of this product.

CONTENTS

Safety and maintenance	02
Name and function of components	04
Function	05
Method of usage	16
Product specification	19

Safety And Maintenance

1. IMPORTANT SAFETY WARNING.



- Don't allow children to touch moveable part of this product.
- Please use well-grounding power supply suited to this product.
- Please pull out the plug after use or before cleaning to avoid injury or Damage to the product.
- Please operate this product according to this manual instruction.
- Don't use accessories which are not recommended.
- Don't use this product outdoors.
- Please read this manual instruction carefully before operation.
- Any other usage that is not listed in this manual instruction is forbidden.
- 20 minutes of usage each time is recommended.
- Please don't use it if the leather is broken or damaged.
- Please don't use it if the cover or leather is damaged.
- Please don't use it if the radiator hole is covered or blocked.
- Please don't drop anything into this product.
- Please don't fall asleep while using this product.
- Please don't use it if drunk or feel unwell.
- Please don't use it within one hour after having meal.
- Please don't make the massage function too strong for avoiding injury.

2. Environment for usage.

- Please don't use it under high temperature and moist environment such as bathroom.
- Please don't use it immediately while the environmental temperature changes sharply.
- Please don't use it under heavy-dusty or caustic environment.
- Please don't use it where there is not enough space or not good ventilation.

3. People who are not suitable to use this product.

- People who are suffering from osteoporosis are not suitable to use this product.
- People who are suffering from heart disease or carrying electronic medical equipment such as heart pacemaker are not suitable to use this product.
- People who are suffering from fever are not suitable to use this product.
- Pregnant women or women that are in menses period are not suitable to use this product.
- People who got injured or skin disease are not suitable to use this product.
- Children under 14-year old or people mentally unbalanced without being Supervised are not allowed to use this machine.
- People who are told by doctor to have rest or people who feel unwell are not suitable to use this product.
- People whose bodies are wet are forbidden to use this product.
- The appliance has a heated surface. persons insensitive to Heat must be careful when using the appliance.

4. Safety.

- Check the voltage if it is suitable to the specification of this product.

Safety And Maintenance

- Don't use wet hand to pull the plug.
- Don't make water go inside this product to avoid electric shock or cause damage to this product.
- Don't damage the wires or change the circuit of this product.
- Don't use wet cloth to clean the electric parts such as switch and plug.
- Be away from this product under power cut state to avoid injury if the power comeback suddenly.
- Stop using this product while it works abnormal, and please consult local agent immediately.
- Stop using this product if you feel unwell, and please consult health care doctor.
- This appliance is not intended for use by persons (including children) with reduced physical, sensory or mental capabilities, or lack of experience and knowledge, unless they have been given supervision or instruction concerning use of the appliance by a person responsible for their safety.
- Children should be supervised to ensure that they do not play with the appliance.
- If the supply cord is damaged, it must be replaced by the manufacturer, its Service agent or similarly qualified persons in order to avoid a hazard.

5. Maintenance.

- This product should be maintained by certain appointed agents, users are prohibited to disassemble or maintain by themselves.
- Please don't forget to cut the power after usage.
- Don't use this product if the socket looses.
- If this product will be left unused for long, please curl up the wires and reserve this product in dry and dustless environment.
- Don't reserve this product under high temperature or near fire and avoid longtime direct sunshine.
- If the detachable cord / supply cord is damaged, it must be replaced by the manufacturer, its service agent or similarly qualified persons in order to avoid a Hazard.
- Please clean this product by dry cloth. Don't use thinner, benzene or alcohol.
- The mechanical components of this product are specially designed and made, it is not necessary to be specially maintained.
- Don't use edged res to thrust this product.
- Don't roll or pull this product above uneven ground, it should be lifted before moving.
- Please use it intermittently; don't make this product work continuously for long.

6. Solution of ordinary malfunctions.

- It is nature movement voice if the motor sounds while in usage.
- If the controller can't work normally, please check the plug and socket if they are connected strongly and make sure the switch is turned on.
- If the rated working time is over, the product will automatically activate the power-off button; If this product works continuously for long, the temperature protector will make the product automatically power-off, it should be used again after half an hour's rest.

Name And Function Of Components

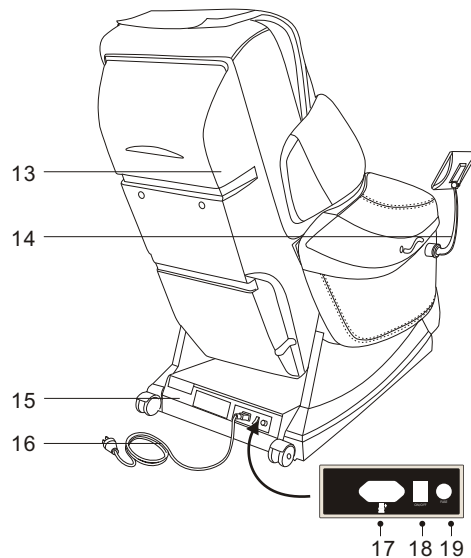
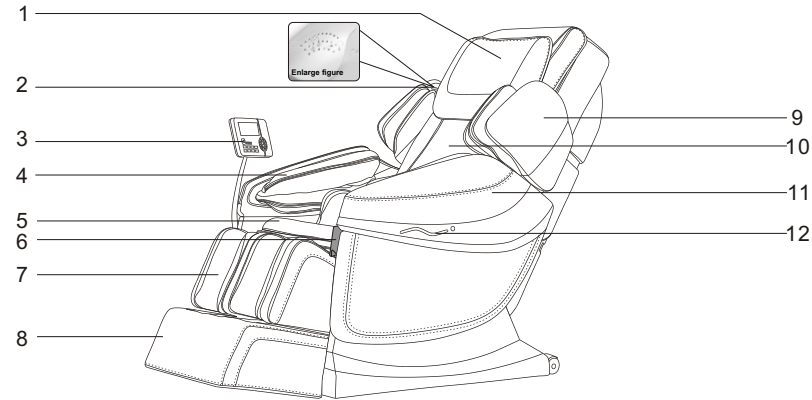

- 1.Pillow pad
- 2.3 D digital audio
- 3.Controller
- 4.Arm air bags assembly
- 5.Seat cushion
- 6.Cell phone pocket
- 7.Legs frame
- 8.Foot frame
- 9.Upper arm air bags assembly
- 10.Back cushion
- 11.Armrest
- 12.LED colorful mood light
- 13.Back cover
- 14.Controller holder
- 15.Base caster
- 16.Power line and power plug
- 17.Power socket
- 18.Power switch
- 19.Fuse box

Function

Functions

- This product is designed with a set of smart 3D mechanical hands, which can move up and down, stretching back and forth, four-wheel driven with muted design
- The shoulder part is designed with automatic detection and micro adjustment function; body curve and massage points automatic detection, it can automatically adjust the distance of massage hands' moving back and forth according to the detected body curve and massage points, to make the massage more humanistic and scientific.
- Comfort, ease, ache relieve, full air pressure, waist twist, waist stretch and other specific massage functions.
- Set with three kinds memo massage functions
- Manually select the upper body massage; three massage position options of overall, partial and fixed position; six massage methods of shoulder grasping, kneading, tapping, shiatsu, kneading &flapping and 3 D; five massage speed levels available; under tapping and shiatsu massage status, the width of the massage hand can be adjusted in five levels.
- Arm air massage function (built-in 26 airbags), upper arm air massage function (built-in 4 airbags), with 3 intensity adjustments
- Lower body air pressure massage function: back air pressure massage function (built in 4 airbags), buttock air pressure massage (built in 5 airbags) legs air pressure massage function (built-in 40 airbags), with 3 intensity adjustments.
- Cell phone MP3 player function, upper arm built in 3 D digital audio
- Back heating function, use carbon fiber as infrared heating source
- Knee heating function, use carbon fiber as infrared heating source
- The footrest can be extended to suit various heights
- Footrest lifting, backrest lift and laying and lie-down models adjustment
- Auto-sitting function, massage hands can automatically return to original position after turning off.
- VFD display
- LED colorful mood light on armrest

Method Of Usage

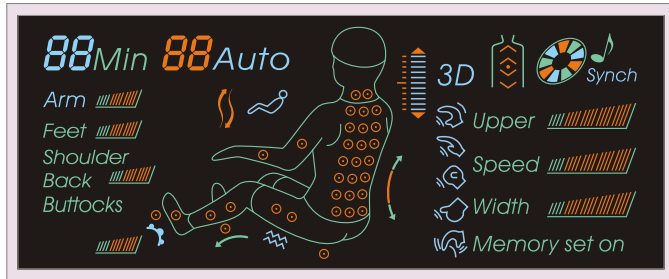

NOTE: this is for reference only, please take practicality as standard

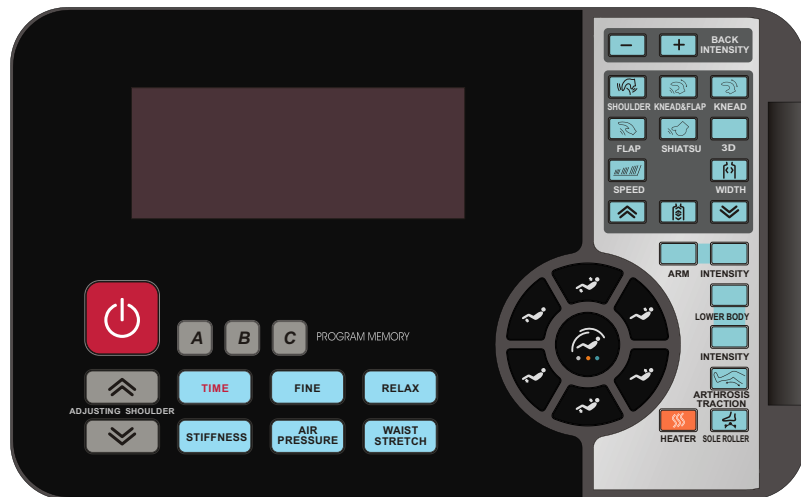

Method Of Usage

1. Switch power supply on



2. Start to massage

- Press the red power button to start massage, the massage chair lie down automatically
- Automatically detecting shoulder position and massage points, please wait till detection finished.
- It sounds [di di di...] after detection finished. Now, please adjust the shoulder position by pressing up or down button. It will run automatic massage if there is no adjustment on shoulder position within 10 seconds.

Move the massage balls upward to a suitable position		
	Shoulder position adjustment (Upper button)	
Move the massage balls downward to a suitable position		
	Shoulder position adjustment (lower button)	

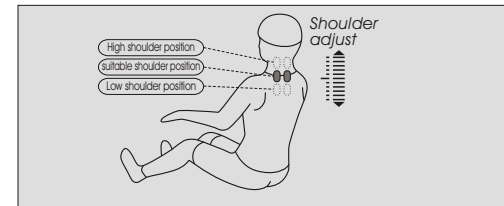

- Choose massage methods
- Memory massage
- When you are massaging, you can use A, B, C memory button at any time, press one of the button, then will back to the stored massage models to massage.







Method Of Usage













• Timing set

Buttons	description
 TIME	Rated time is 20 minutes. Max working time is 40 minutes. Every time press on timing set button add to 5 more minutes. Working time up to 40 minutes, press on timing set button return to 5 minutes. Follow by cycle.









• Automatically massage

 FINE	Comfort: relax muscles and bones	<i>F1 Auto</i>
 RELAX	Ease: promote blood circulation	<i>F2 Auto</i>
 STIFFNESS	Ache relieve: make deep massage to relax the ache position	<i>F3 Auto</i>
 AIR PRESSURE	Whole-body air pressure massage: waist, buttock, arms, legs air pressure massage work at the same time.	<i>F4 Auto</i>
 WAIST STRETCH	Waist stretch: When the calf airbags work and squeeze calf part, the backrest lays down and calf rest pulls down to stretch the waist part, then return to original position and repeat above actions. Meantime the seat airbags and massage mechanism works.	<i>F5 Auto</i>

• Manual functions











Buttons	description	display
 SHOULDER	Grasp: built in 1 massage method, speed and strength adjustable	 (H1)
 KNEAD&TAP	Kneading & taping: built in 1 massage method, speed and strength adjustable	 (H1)
 KNEAD	Kneading: built in 1 massage method, speed and strength adjustable	 (H1)
 TAPPING	Taping: built in 2 massage methods, speed, width and strength adjustable	 (H1-H2)
 SHIATSU	Shiatsu: built in 2 massage methods, speed width and strength adjustable	 (H1-H2)
 3D	3 D: built in 4 massage methods, speed and strength adjustable	3D (H1-H4)
 SPEED	Speed: with 5 levels available	Speed 
 WIDTH	Width: 5 levels available (in taping and kneading massage mode)	Width 

Method Of Usage

Buttons	description	display
 BACK STRETCH	Fixed position (fixed point) massage	
 BACK STRETCH	Small area (partial) massage back and forth	
 BACK STRETCH	Upper body (overall) back and forth	
 LOWER ADJUST	Massage position adjust (can adjust the massage position in fixed position, partial mode)	Mechanical hands move downward
 UPPER ADJUST		Mechanical hands move upward









Note: back stretch (except shoulder grasp, other manual modes are effective)

• Air pressure massage







Buttons	description	display
 ARM	Arms: press this button, the arm air pressure and upper arm air pressure massage function on	Arm 
 INTENSITY	Strength: arm air pressure strength has 3 levels adjustable	Arm 
 LOWER BODY	Lower body: press this button and choose lower body air pressure massage function (including lower body, back and waist, calf)	Feet  Back  buttocks 
 INTENSITY	Intensity: air pressure massage intensity of lower body, back and waist, calf. Three intensity available.	
 ARTHROSIS TRACTION	The function of calf stretch will be enabled automatically under the mode of lower body air pressure massage and calf air pressure massage.	

Method Of Usage

• Other manual function

Buttons	description	display
 BACK STRENGTHEN BUTTON	Back weaken button: press this button, weaken the strength of upper body massage	Upper 
 BACK WEAKEN BUTTON	Back strengthen button: press this button, strengthen the strength of upper body massage	Upper 
 SOLE ROLLER	Sole roller: sole roller switch, with 3 speed levels available	
 HEATER	Warm therapy: back heating and knee heating switch, has warm feeling when it start to work 3 minutes later.	

3.The angle of back rest and calf rest

Buttons	description	display
	Auto lay down mode: with 3 auto lay down modes, when press the button, turn into one mode.	(01 ~ 03) Auto
	Calf rest lifting button: press this button, calf rest lifting slowly, stop when release it.	
	Calf rest decline button: press this button, calf rest decline slowly, stop when release it.	
	Back rest lifting button: press this button, back rest lifting slowly, stop when release it.	
	Back rest decline button: press this button, back rest decline slowly, stop when release it.	
	Linkage upward: press this button, the back rest lifting slowly, and the calf rest decline slowly at the same time, stop when release it.	
	Linkage downward: press this button, the back rest decline slowly, and the calf rest lifting slowly at the same time, stop when release it.	

4. Other function

- Cell phone music: set cell phone pocket in left arm rest, audio equipment built in, make the music and massage working at same time, share the rhythm of the music when massaging.

Method Of Usage

- With a 3 D digit audio equipment on each side of the upper arm of armrest, connect with cell phone music, and played through the 3 D digit audio equipment, you will enjoy music and massage when relaxing
- Colorful light on armrest: with colorful light on each side, red, green, blue, blue-green, purple, yellow, white changed automatically.

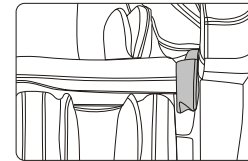

Cell phone pocket (audio interface)



3 D digit audio



LED colorful mood light

5.Shut off power and finish massage

- Press red power button during massage to stop all massage functions immediately, the backrest and footrest will return to original position automatically. After rated working time, all massage functions will be finished but backrest and footrest won't return to original position.
- After rated working time or switch off, the handle controller displayed "Memory Set On" and glitter, and remind the users whether need to store the massage mode before turn off, you can choose the memo function buttons A, B, C as your requirement, store the massage mode. Press the red button again, the machine turn off, and the massage hands will restore to the original position, or wait for 10 seconds, the machine turn off automatically, and the massage restore to the original position.

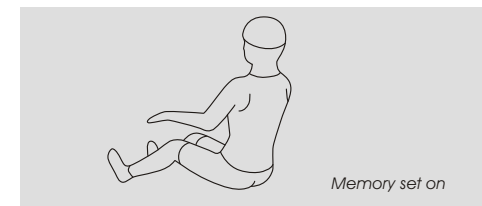

- Switch power off
Figure (Cut off the power of the machine)

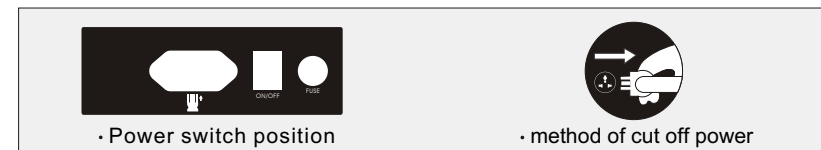

Method Of Usage

6. Am rest installation

- Find out the plug respond to the arm rest on the bottom of the seat frame, and through out from the square hole which on the fixed steel board.(figure 1)
- When the plug out from the square hole on the steel board, respond to every connecting plug(figure 2)

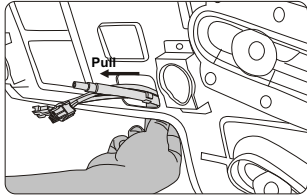

(Figure 1)

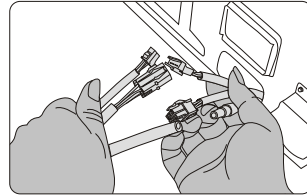

(Figure 2)

- Draw out the plug on the bottom of the seat frame and connect with the arm rest joint, air pipe responded to the right place (figure 3)
- After connect the responded connector, insert it gently through the square hole on the bottom of the seat frame, be careful to avoid to fold the air pipe (figure 4)

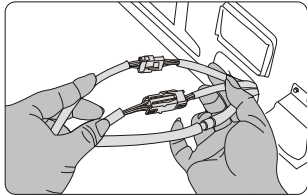

(Figure 3)

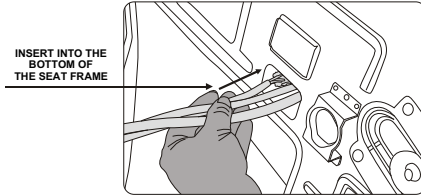

(Figure 4)

- As figure, the pin on the arm rest respond to the box on the fix board, the steel board respond to the groove of arm rest.(figure 5)
- Hold the arm rest with your hands, pin respond to box on the front part of the steel board, and pin respond to box on the behind of the armrest,(check the connect wire whether it is insert in to the bottom of the armrest frame, avoid to get stuck), the whole arm rest covered on the fixed steel board. (figure 6)

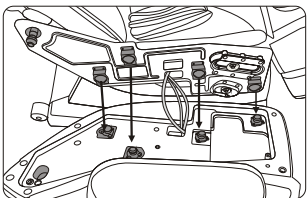

(Figure 5)

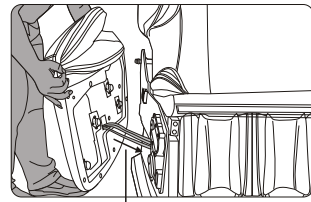

(Figure 6)

Note: the connect wire must be insert in the right place, avoid to get stuck

Method Of Usage

- Arm rest covered on the fixed steel board, then press the armrest make sure the pin into the box on the fixed steel board, and pull it with your hand to check it is fasten tightly.(figure 7)
- Find out the install hole on the front part of the fixed steel board, screw the screws with hex wrench. (Figure 8)
- Find out the install hole on the behind part of the fixed steel board, screw the screws with hex wrench, finish the installation, the same installation of the two armrest. (figure 9)

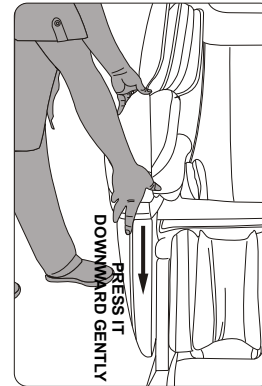

(Figure 7)

Figure: hex head screw fixed in front part of armrest (Figure 8)

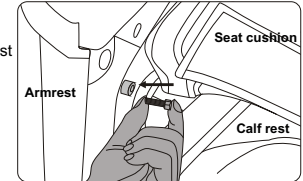
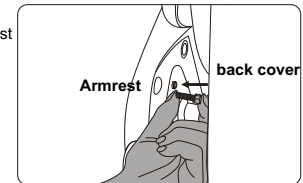
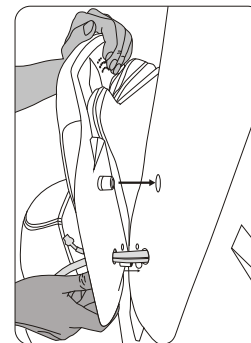

Figure: hex head screw fixed in behind part of armrest (Figure 9)



7. Upper armrest installation

- Air pipe and trumpet line in backrest cross upper armrest and pipe hole. Two guide pillars of upper armrest insert relevant hole on backrest cover(Figure 1).
- Upper armrest pressed tightly by hand. Fixed the upper armrest on armrest cover by two cross recessed pan head screws(Figure 2)



(Figure 1)

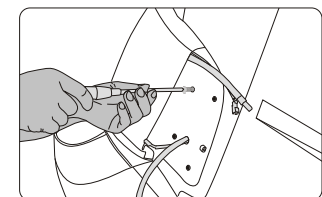

(Figure 2)

Method Of Usage

- Joint the upper armrest, trumpet line in backrest and the air pipe. Make sure the connection is well and without air leak(Figure 3).
- After the connected air pipe and trumpet line, please surround the cable within upper armrest. Do not fold any pipe or cable(Figure 4).

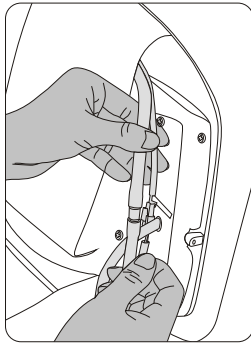

(Figure 3)

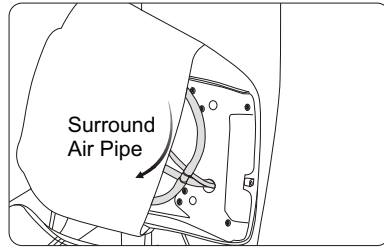

(Figure 4)

- Installation of decoration bar. Insert it into upper armrest cover slot. Lightly press inward rim make it fit. Be careful of damage rim during installation(Figure 5).
- Tighten decoration bar with supplied cross recessed pan head screws(Figure 6)

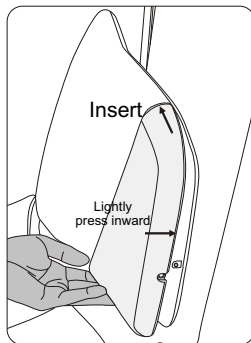

(Figure 5)



(Figure 6)

Method Of Usage

8.Handle controller frame installation

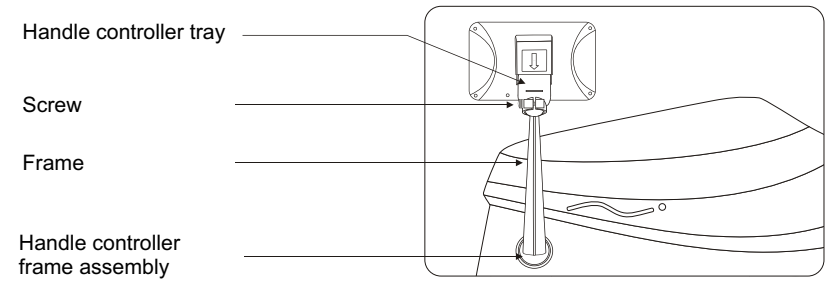

- Ready for the handle controller tray, steel pole, take out the fixed screws on the handle controller tray. (Figure 1)
- Insert the ball joint of the steel pole to the concave spherical of the handle controller tray.(figure 2)

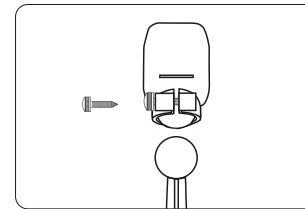

(Figure 1)

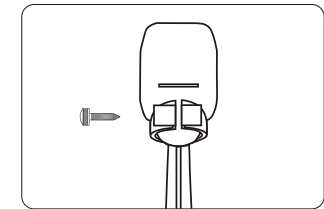

(Figure 2)

- Screw the screws in to the hole which got in step 1 and tighten it, take care the direction, should be screw it from right to left. (Figure 3)
- Prepare the cylindrical fixed pipe.(Figure 4)

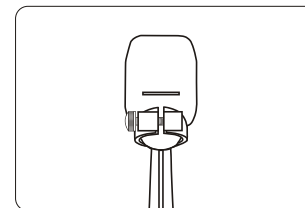

(Figure 3)

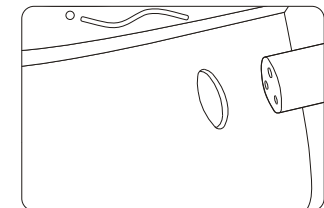

(Figure 4)

Method Of Usage

- Put the cylindrical fixed pipe in to the hole on the right armrest, take care that the sphere hole on the fixed pipe should be one to one corresponded with the hole on the arm rest of the flange plate. (figure 5)
- Screw three screws to tighten it (figure 6)

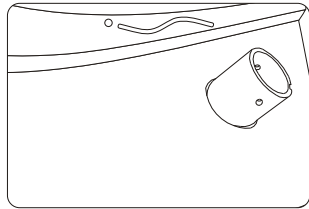

(Figure 5)

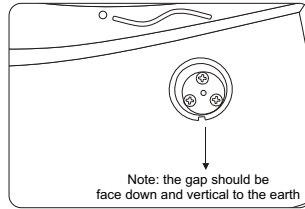

(Figure 6)

- Prepare the handle controller frame assembly in step 3.(figure 7)
- Insert the handle controller frame assembly in to the cylindrical fixed pipe, be carefully that the two groups hole out side and inside should be one to one correspond.(figure8)

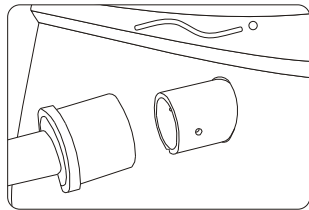

(Figure 7)

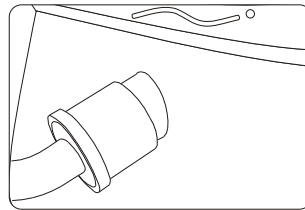

(Figure 8)

- Prepare two screws which tighten on two sides (figure 9)
- Screw the two screws on two sides make it tighten, finish the installation(figure 10)

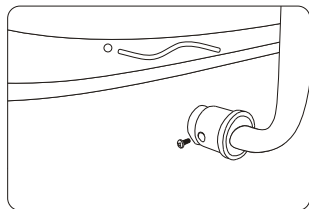

(Figure 9)

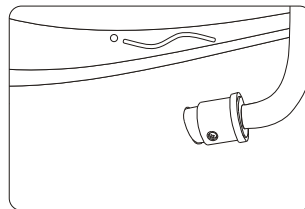

(Figure 10)

Method Of Usage

9.Controller installation and usage

Insert the handle controller in to the frame (figure 1), the frame can turn left and right freely. (Figure 2) and the handle controller can swing freely in horizontal direction.

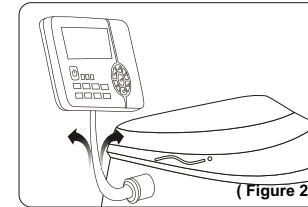
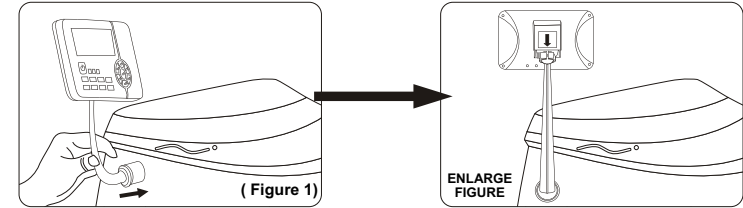

(Figure 2)

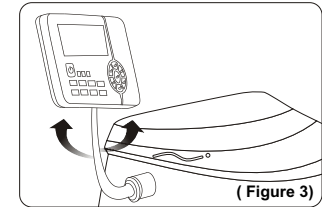

(Figure 3)

10.The disassemble and using of pillow pad and back cushion

You can weaken the kneading strength of the neck and shoulder by pillow pad, you can use it according to your requirement (Advise you use it). Back cushion connect with back by zipper (1), pillow pad connect with the back cushion by fastener (2)

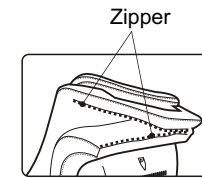
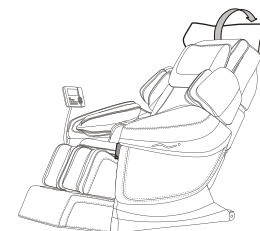

(1)

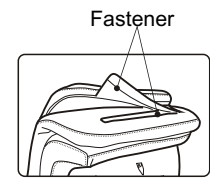

(2)

Method Of Usage

11. Floor Protection

Put the heavy massage chairs on the wood floor for a long time may damage the floor, so please place a carpet or other object to avoid this damage.

Caution: Do not move the chairs with its wheels on wood floor, rough ground or in a narrow space. Two people are required to lift the chair.

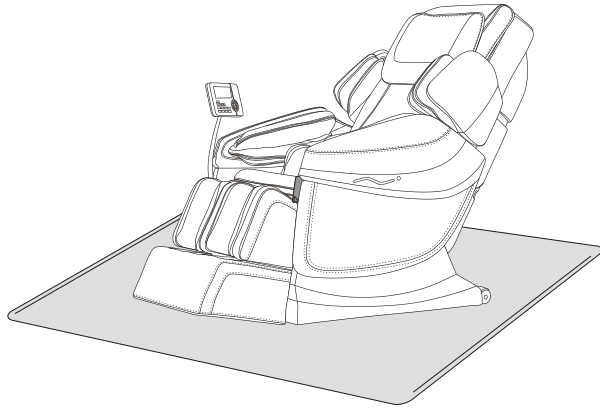

12. Method Of Movement

Make sure that all wires are far above the ground, tilt the backrest backward to a certain degree (with the gravity center resting on the wheels), push the chair forward or backward with your hands and finally resume the chair to the normal position in a slow and gentle manner.

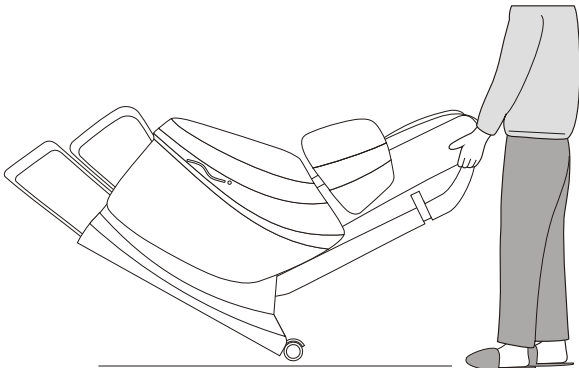

Product Specification

Model: A50

Description: Full Body Air-massage Chair

Rated Voltage: 110-120V~ 60Hz
220-240V~ 50Hz / 60Hz

Rated Power Input: 200W

Rated Working Time: 20Minutes

Safety Design: Class I

Material introduction: PVC, PA, steel parts and electric &ele-ctron parts

MATERIAL	PU	LEATHER	CLOTH	WOOD

