

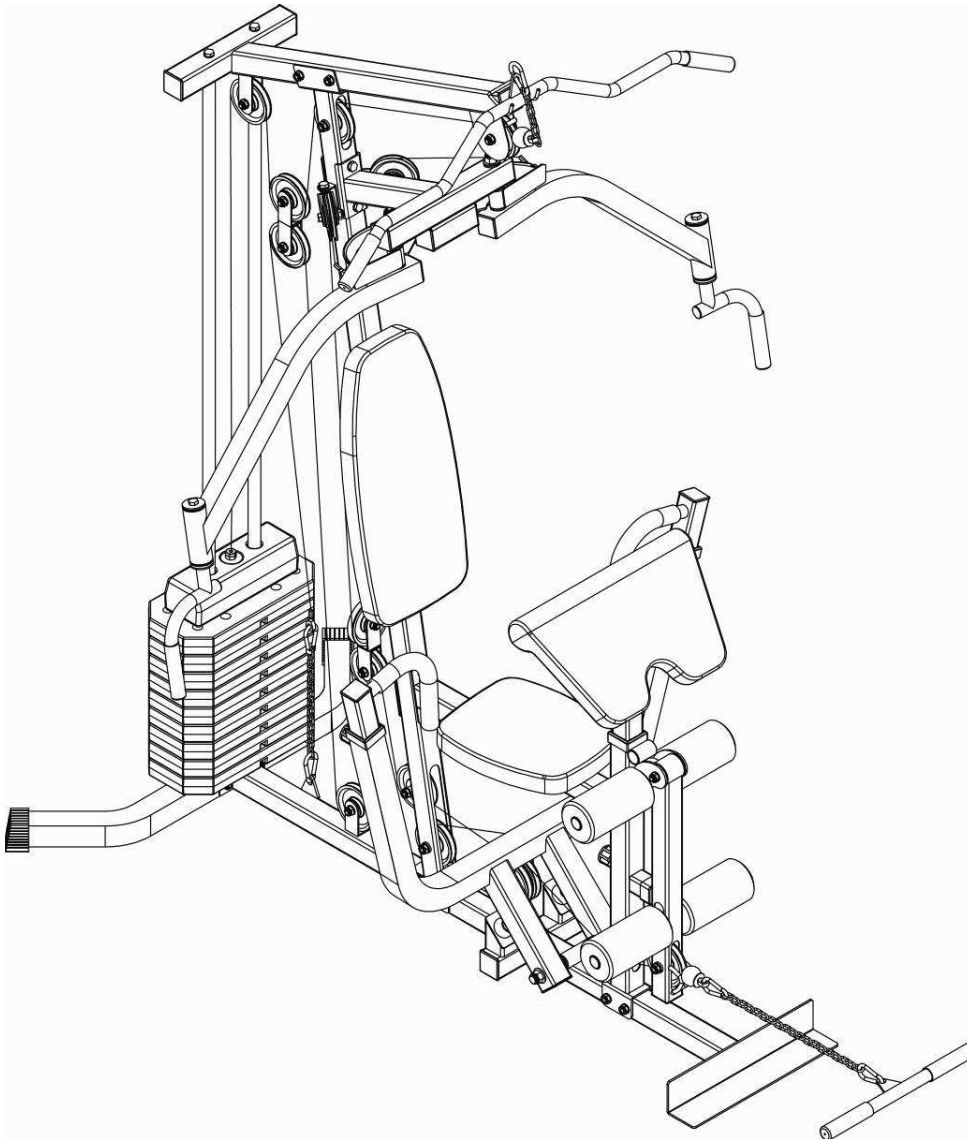









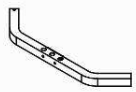











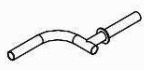





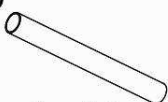
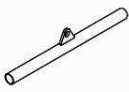

















































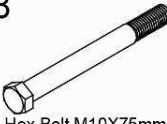

USER MANUAL - EN
IN 7186 Home gym inSPORTline Profigym C50

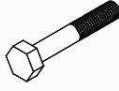

PATRS LIST

1  Main Base 1pc	2  Rear Base 1pc	3  Weight Guide Tube 2pcs	4  Vertical Post 1pc	5  Top Beam 1pc
6  Butterfly Extension 1pc	7  Left Butterfly Arm 1pc	8  Right Butterfly Arm 1pc	9  Seat Cushion Support 1pc	10  Seat Support Post 1pc
11  Leg Extension 1pc	12  Arm Curl Frame 1pc	13  Bench Press Arm 1pc	14  Handle Tube 1pc	15  Left Adjustable Plate 1pc
16  Right Adjustable Plate 1pc	17  Right Press Arm 1pc	18  Left Press Arm 1pc	19  Handle Foam(short) 2pcs	20  Foam Rod 2pcs
21  Low Bar 1pc	22  Single Pulley Bracket 2pcs	23  Pulley U 1pc	24  Reverse U 1pc	25  Shaft 1pc
26  Lat Bar 1pc	27  Weight Selection Rod 1pc	28  Arm Curl Cushion 1pc	29  Seat Cushion 1pc	30  Backrest Cushion 1pc
31  Weight Selector Pin 1pc	32  Rubber Ring 2pcs	33  Top Plate 1pc	34  Weight Plate 9pcs	35  Plastic Cover 2pcs
36  Selector Shaft Pin 1pc	37  Selector Shaft Bushing 1pc	38  Plastic Washer 1pc	39  Pulley (3.5") 15pcs	40  Big Pulley (4.5") 1pc
41  Foam Roller 4pcs	42  Press Arm Foam (Long) 2pcs	43  Oil Bushing (Small) 14pcs	44  Oil Bushing (Big) 4pcs	45  Quick Knob(short) 3pcs
46  Ankle Strap 1pc	47  Chain (390mmL) 1pc	48  Chain(260mmL) 1pc	49  Chain (120mmL) 1pc	50  Rubber Sticker 1pc

PATRS LIST

<p>51</p>  <p>Lower Cable 1pc</p>	<p>52</p>  <p>Butterfly Cable 1pc</p>	<p>53</p>  <p>Upper Cable 1pc</p>	<p>54</p>  <p>Hand Grip 4pcs</p>	<p>55</p>  <p>38mm Square End Cap 1pc</p>
<p>56</p>  <p>50mm Square End Cap 2pcs</p>	<p>57</p>  <p>Bumper 2pcs</p>	<p>58</p>  <p>Plastic Bushing(Long) 6pcs</p>	<p>59</p>  <p>Plastic Bushing(Short) 2pcs</p>	<p>60</p>  <p>45mm Square End Plug 5pcs</p>
<p>61</p>  <p>50mm Square End Plug 11pcs</p>	<p>62</p>  <p>25mm Round End Plug 10PCS</p>	<p>63</p>  <p>Select Bar End Plug 1pc</p>	<p>64</p>  <p>Mid-empty plug(∅50X∅45) 3pcs</p>	<p>65</p>  <p>Plastic Bushing(Big) 2pcs</p>
<p>66</p>  <p>Quick Knob(long) 2pcs</p>	<p>67</p>  <p>Pothook 6pcs</p>	<p>68</p>  <p>Hex Bolt M10X75mm 1pc</p>	<p>69</p>  <p>Hex Bolt M10X70mm 15pcs</p>	<p>70</p>  <p>Hex Bolt M10X65mm 6pcs</p>
<p>71</p>  <p>Hex Bolt M10X45mm 9pcs</p>	<p>72</p>  <p>Hex Bolt M10X20mm 6pcs</p>	<p>73</p>  <p>Hex Bolt M8X65mm 2pcs</p>	<p>74</p>  <p>Hex Bolt M8X15mm 6pcs</p>	<p>75</p>  <p>M6*20 Bolt 2pcs</p>
<p>76</p>  <p>Washer (∅45X∅11) 2pcs</p>	<p>77</p>  <p>M16 Washer 4pcs</p>	<p>78</p>  <p>M10 Washer 66pcs</p>	<p>79</p>  <p>M8 Washer 8pcs</p>	<p>80</p>  <p>M16 Nylon Nut 4pcs</p>
<p>81</p>  <p>M10 Nylon Nut 31pcs</p>				

ASSEMBLY INSTRUCTIONS

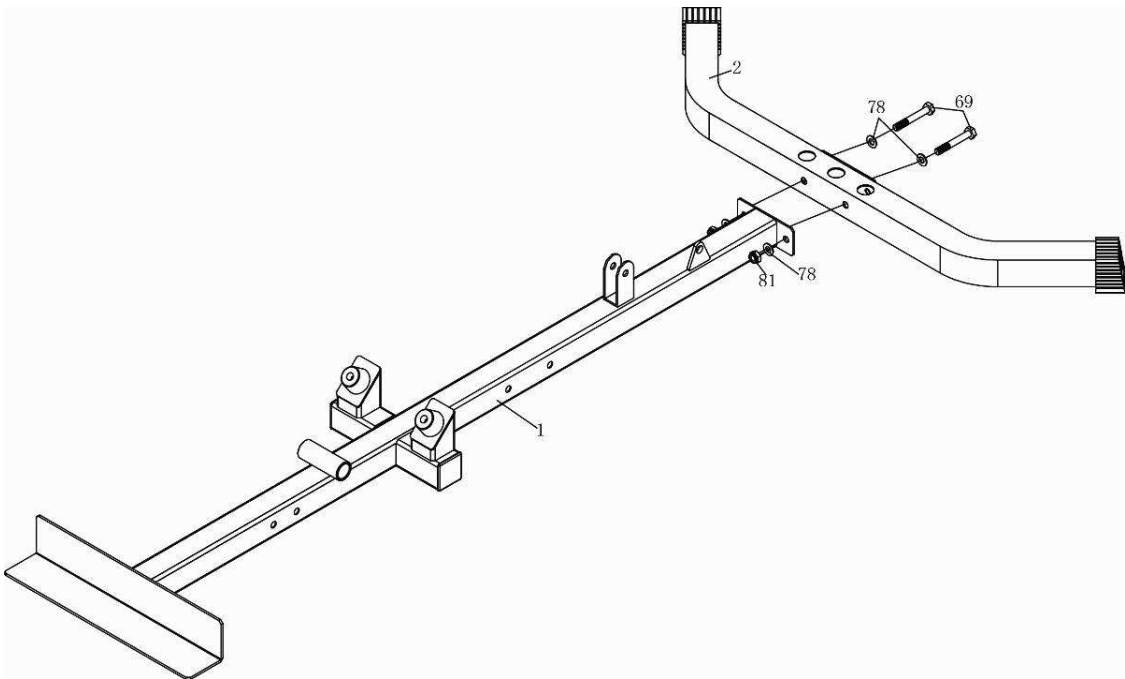

STEP 1:

1. Attach Main Base (1) to Rear Base (2), using two M10×70mm Hex Bolts (69), four M10 Washers (78) and two M10 Nylon Nuts (81).

ASSEMBLY INSTRUCTIONS

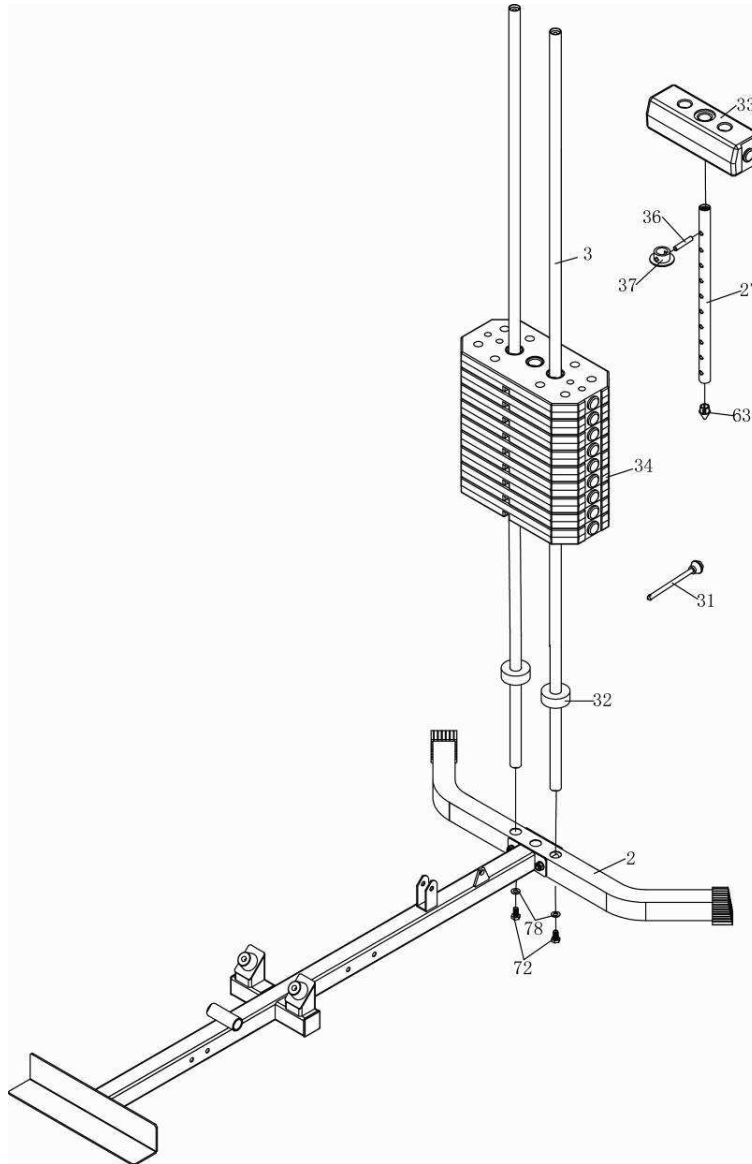

STEP2:

1. Remove two M10x20mm Hex Bolts (72) and two M10 Washers (78) from two Weight Guide Tubes (3).
2. Insert the Weight Guide Tube (3) into the Rear Base (2), using two M10x20mm Hex Bolts (72) and two M10 Washers (78).
3. Slide the two Rubber Rings (32) onto the two Weight Guide Tubes (3).
4. Slide the nine Weight Plates (34) down Weight Guide Tube (3).
5. Slide Selector Shaft Bushing (37) down Weight Selection Rod (27) at First hole fix with Selector Shaft Pin (27).
6. Insert Weight Selection Rod (27) into hole of Weight Plate (34).
7. Slide Top Plate (33) down Weight Selection Rod (27), Insert Weight Selector Pin (27) into hole of desired Weight.

ASSEMBLY INSTRUCTIONS

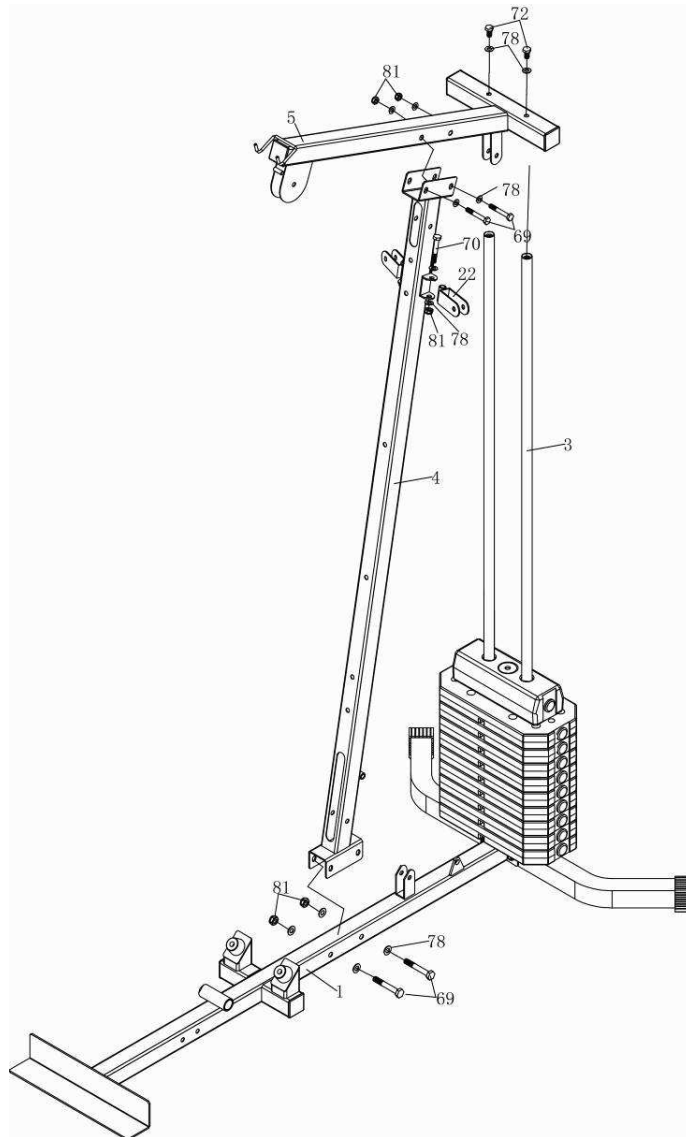

STEP3:

1. Attach the Vertical Post (4) to the Main Base (1), using two M10x70mm Hex Bolts (69), four M10 Washers (78) and two M10 Nylon Nuts (81).
2. Remove two M10x20mm Hex Bolts (72) and two M10 Washers (78) from two Weight Guide Tubes (3).
3. Attach the Top Beam (5) to the two Weight Guide Tubes (3), using two M10x20mm Hex Bolts (72) and two M10 Washers (78).
4. Attach the Top Beam (5) to the Vertical Post (4), using two M10x70mm Hex Bolts (69), four M10 Washers (78) and two M10 Nylon Nuts (81).
5. Attach the two Single Pulley Brackets (22) to the Vertical Post (4), using two M10x65mm Hex Bolts (70), four M10 Washers (78) and two M10 Nylon Nuts (81).

ASSEMBLY INSTRUCTIONS

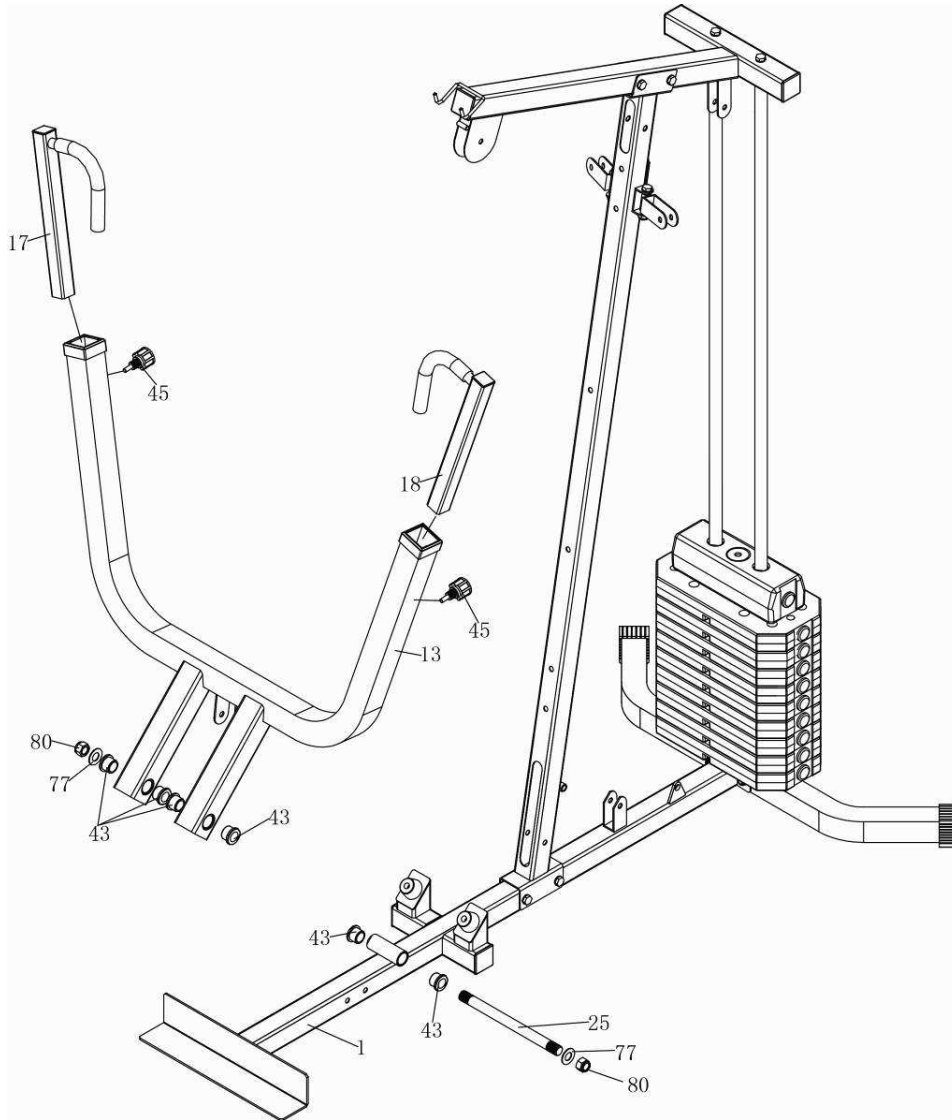

STEP4:

1. Attach Bench Press Arm (13) to Main Base (1), using Shaft (25), six Oil Bushing (Small) (43), two M16 Washers (77) and two M16 Nylon Nuts (80).
2. Insert the Left & Right Press Arms (17&18) into the Bench Press Arm (13), using two Quick Knobs (short) (45).

ASSEMBLY INSTRUCTIONS

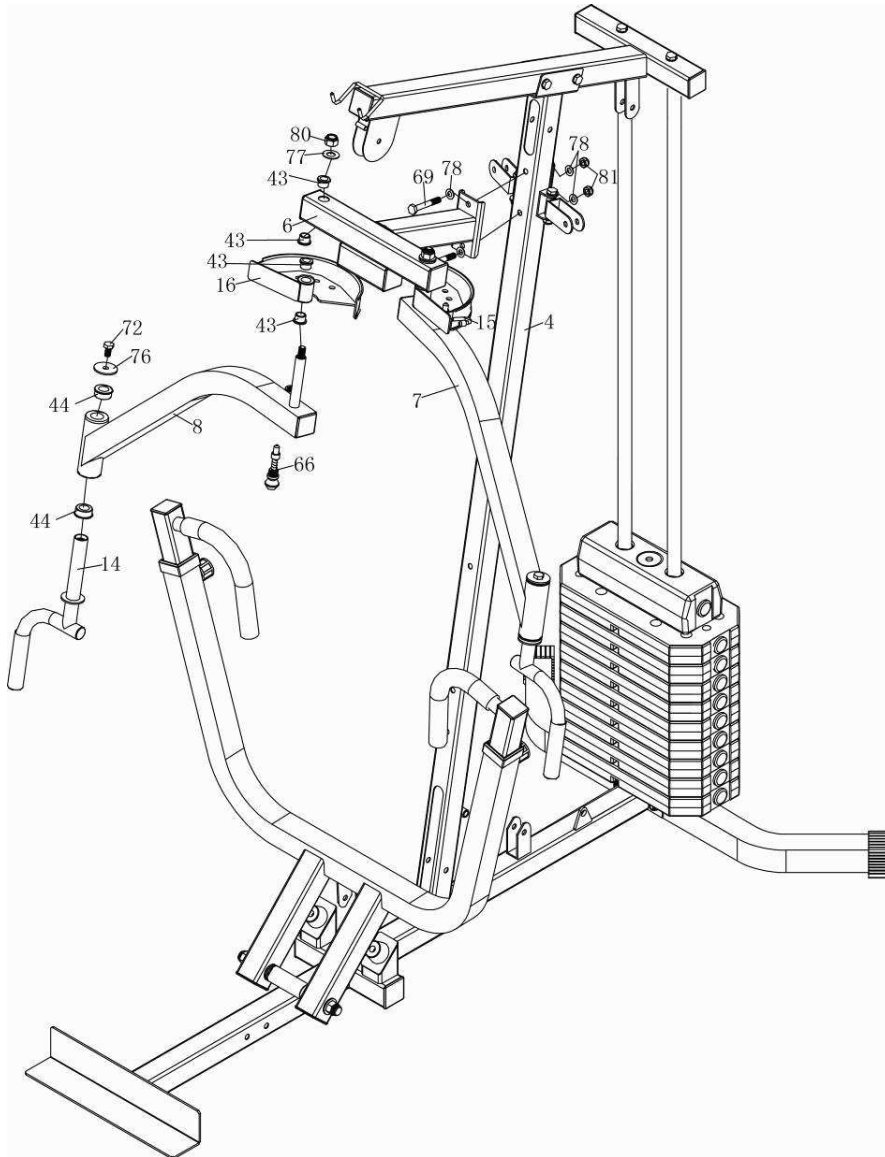

STEP5:

1. Attach the Butterfly Extension (6) to Vertical Post (4), using two M10x70mm Hex Bolts (69), four M10 Washers (78) and two M10 Nylon Nuts (81).
2. Tap Oil Bushing (small) (43) to Right Adjustable Plate (16).
3. Slide Right Adjustable Plate (16) onto Right Butterfly Arm (8), then insert Quick Knob (long) (66) through the single hole on the Right Adjustable Plate (16) to any one of the holes on the fan-type plate.
4. Attach Right Butterfly Arm (8) to Butterfly Extension (6), using two Oil Bushings (small) (43), one M16 Washer (77) and one M16 Nylon Nut (80).
5. Attach Handle Tube (14) to the Right Butterfly Arm (8), using two Oil Bushings (big), one M10x20mm Hex Bolt (72) and one Washer ($\varnothing 45 \times \varnothing 11$) (76).
6. Assemble Left Butterfly Arm (7) and Left Adjustable Plate (15) with same method.

ASSEMBLY INSTRUCTIONS

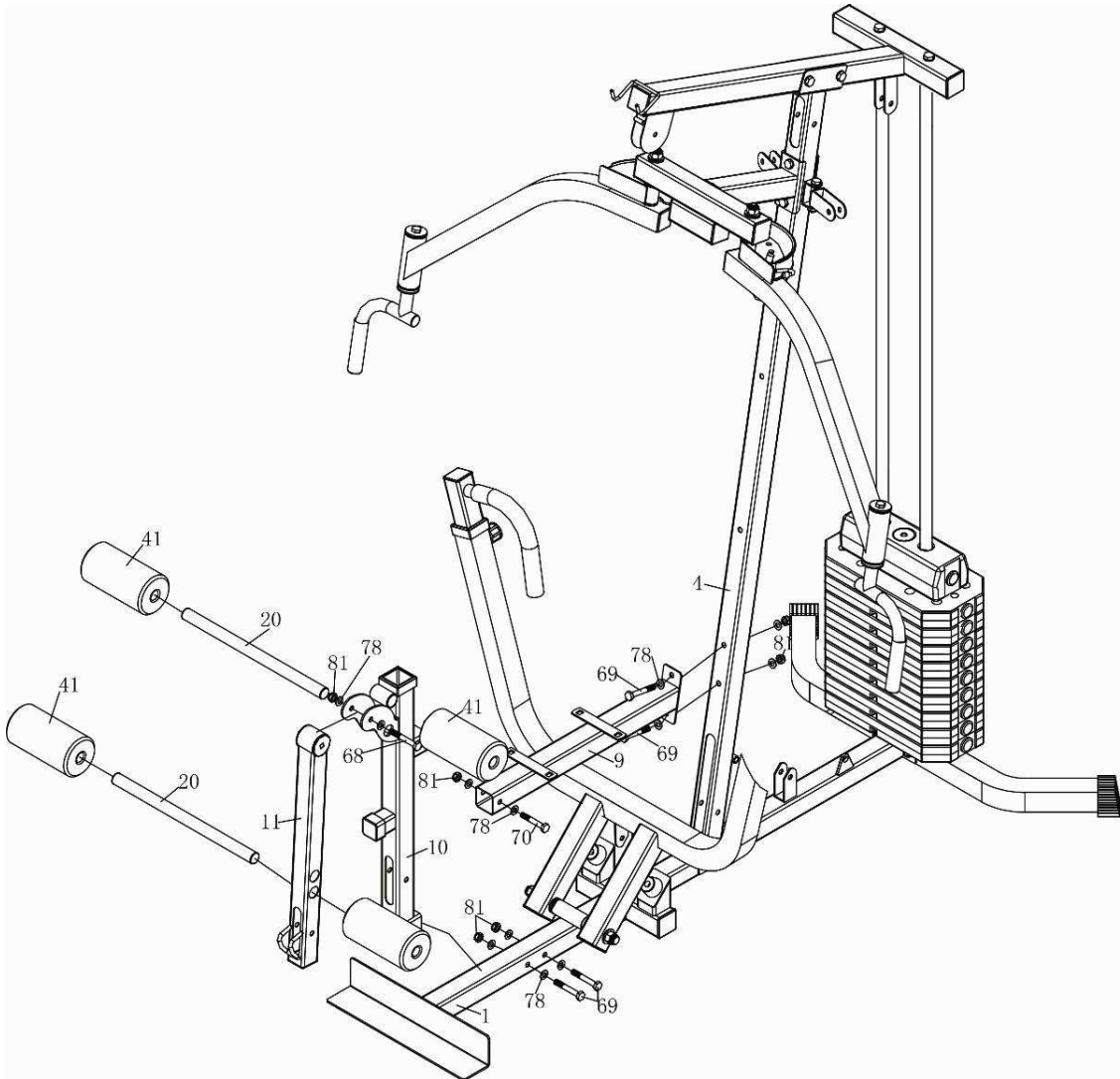

STEP6:

1. Attach Seat Cushion Support (9) to Vertical Post (4), using two M10x70mm Hex Bolts (69), four M10 Washers (78) and two M10 Nylon Nuts (81).
2. Attach Seat Support Post (10) to Seat Cushion Support (9), using one M10x65mm Hex Bolt (70), two M10 Washers (78) and one M10 Nylon Nut (81).
3. Attach Seat Support Post (10) to Main Base (1), using two M10x70mm Hex Bolts (69), four M10 Washers (78) and two M10 Nylon Nuts (81).
4. Attach Leg Extension (11) to Seat Support Post (10), using one M10x75mm Hex Bolt (68), two M10 Washers (78) and one M10 Nylon Nut (81).
5. Insert the Foam Rod (20) into the Seat Support Post (10) and Leg Extension (11), then slide Foam Roller (41) onto the Foam Rod (20).

ASSEMBLY INSTRUCTIONS

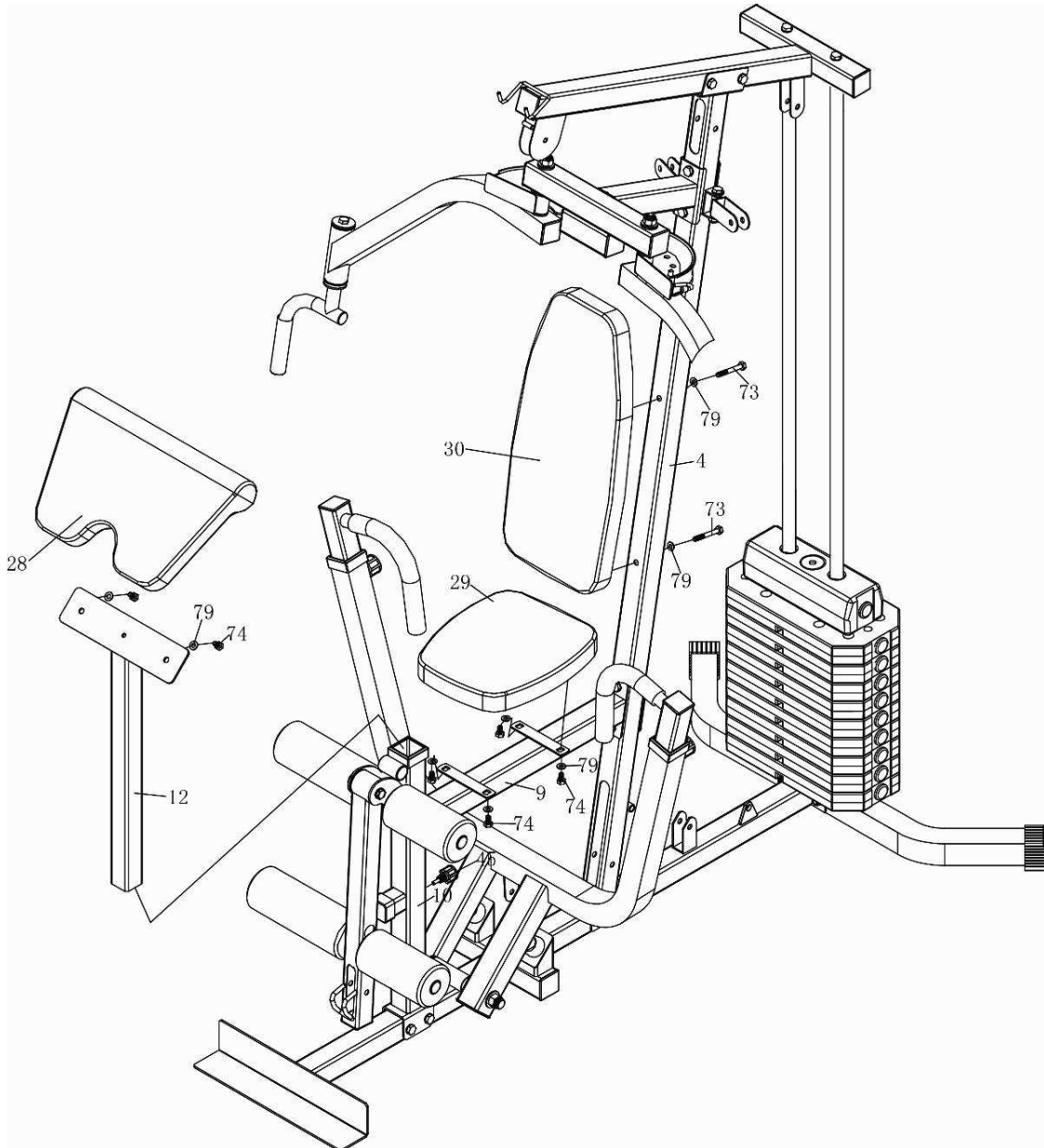

STEP7:

1. Attach Backrest Cushion (30) onto Vertical Post (4), using two M8×65mm Hex Bolts (73) and two M8 Washers (79).
2. Attach Seat Cushion (29) onto Seat Cushion Support (9), using four M8×15mm Hex Bolts (74) and four M8 Washers (79).
3. Attach Arm Curl Cushion (28) to Arm Curl Frame (12), using two M8×15mm Hex Bolts (74) and two M8 Washers (79).
4. Insert the Arm Curl Frame (12) into the Seat Support Post (10), using Quick Knob (short) (45).

ASSEMBLY INSTRUCTIONS

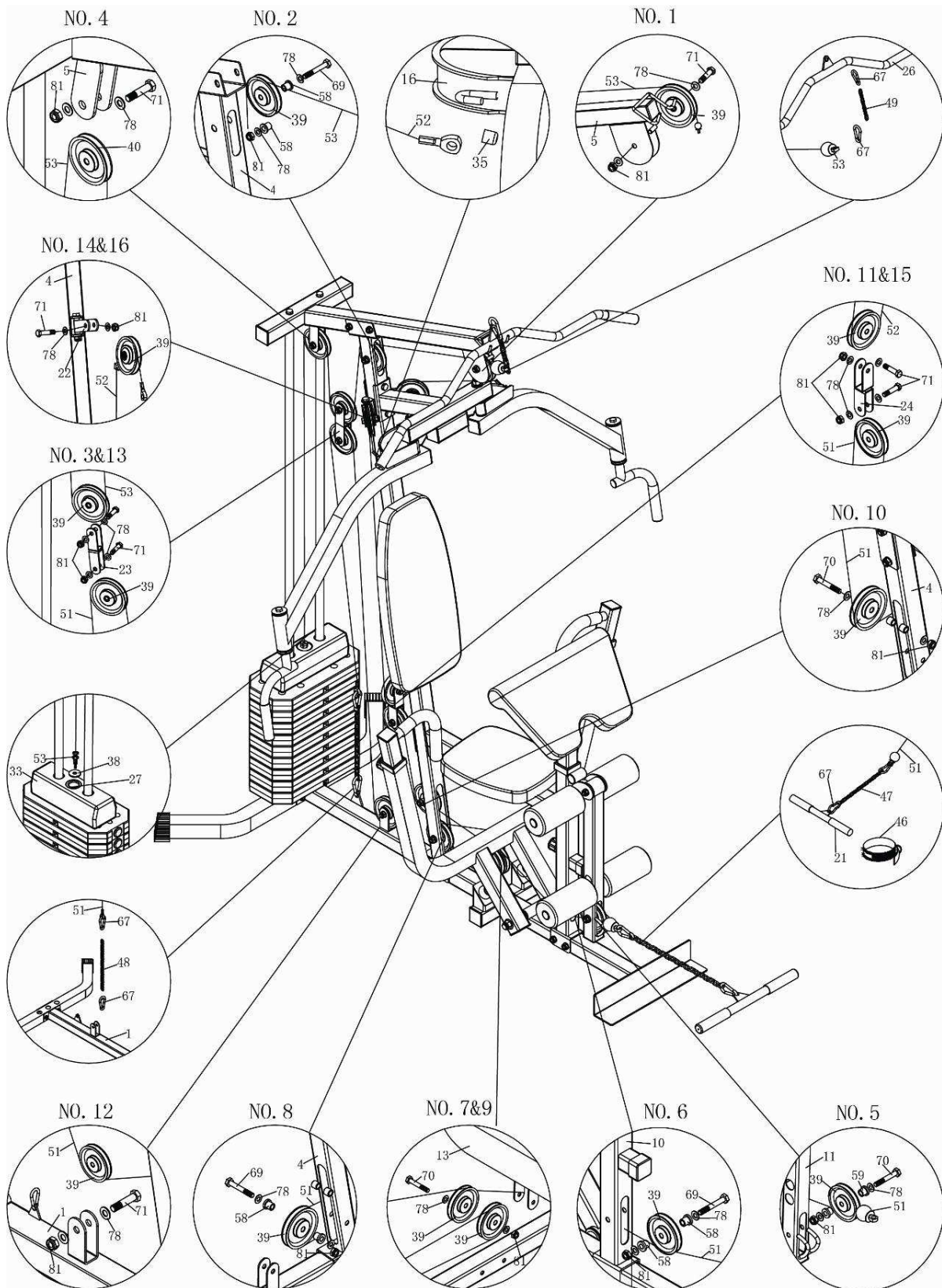

ASSEMBLY INSTRUCTIONS

STEP 8:

1. Start with the Upper Cable (53)
 - a). With Upper Cable (53) in groove of Pulley (39), thread Upper Cable (53) through Top Beam (5).
 - b). Install Pulley NO.1 (39) to Top Beam (5), using one M10x45mm Hex Bolt (71), two M10 Washers (78) and one M10 Nylon Nut (81).
 - c). Install Pulley NO.2 (39) and two Plastic Bushing (Long) (58) to Vertical Post (4), using one M10x70mm Hex Bolt (69), two M10 Washers (78) and one M10 Nylon Nut (81).
 - d). Install Big Pulley NO.4 (40) to Top Beam (5), using one M10x45mm Hex Bolt (71), two M10 Washers (78) and one M10 Nylon Nut (81).
 - e). Attach the bolt end of Upper Cable (53) to Weight Selection Rod (27) with Plastic Washer (38).
 - f). Attach the other end of Upper Cable (53) to Lat Bar (26), using two Pothooks (67) and one Chain (120mmL) (49).
 - g). Install Pulley NO.3 (39) to Pulley U (23), using one M10x45mm Hex Bolt (71), two M10 Washers (78) and one M10 Nylon Nut (81).

2. Assembly the Butterfly Cable (52)
 - a). Attach both end of Cable (52) to left and right Adjustable Plate (15&16), using two Plastic Covers (53).
 - b). Install Pulley NO.14 &16 (39) to Single Pulley Bracket (22), using two M10x45mm Hex Bolts (71), four M10 Washers (78) and two M10 Nylon Nuts (81).
 - c). Install Pulley NO.15 (39) to Reverse U (24), using one M10x45mm Hex Bolt (71), two M10 Washers (78) and one M10 Nylon Nut (81).

3. Assembly the Lower Cable (51).
 - a.) With the Lower Cable (51) in groove of Pulley (39) through Leg Extension (11).
 - b.) Install Pulley NO.5 (39) and two Plastic Bushing (Short) (59) to the Leg Extension (11), using one M10x65mm Hex Bolt (70), two M10 Washers (78) and one M10 Nylon Nut (81).
 - c.) Install Pulley NO.6 (39) and two Plastic Bushing (Long) (58) to Seat Support Post (10), using one M10x70mm Hex Bolt (69), two M10 Washers (78) and one M10 Nylon Nut (81).
 - d.) Install Pulley NO.7 & 9 (39) to Bench Press Arm (13), using one M10x65mm Hex Bolt (70),two M10 Washers (78) and one M10 Nylon Nut (81).
 - e.) Install Pulley NO.8 (39) and two Plastic Bushing (Long) (58) to Vertical Post (4), using one M10x70mm Hex Bolt (69), two M10 Washers (78) and one M10 Nylon Nut (81).
 - f.) Install Pulley NO.10 (39) to Vertical Post (4), using one M10x65mm Hex Bolt (70), two M10 Washers (78) and one M10 Nylon Nut (81).
 - g.) Install Pulley NO.11 (39) to Reverse U (24), using one M10x45mm Hex Bolt (71), two M10 Washers (78) and one M10 Nylon Nut (81).
 - h.) Install Pulley NO.12 (39) to Main Base (1), using one M10x45mm Hex Bolt (71), two M10 Washers (78) and one M10 Nylon Nut (81).
 - i.) Install Pulley NO.13 (39) to Pulley U (23), using one M10x45mm Hex Bolt (71), two M10 Washers (78) and one M10 Nylon Nut (81).
 - j.) Attach the end of Cable (51) to the Main Base (1), using two Pothook (67) and one Chain (260mmL) (48).
 - k.) Attach Low Bar (21) or Ankle Strap (46) to the other end of Cable (51), using two Pothooks (67) and one Chain (390mmL) (47).

ASSEMBLY INSTRUCTIONS

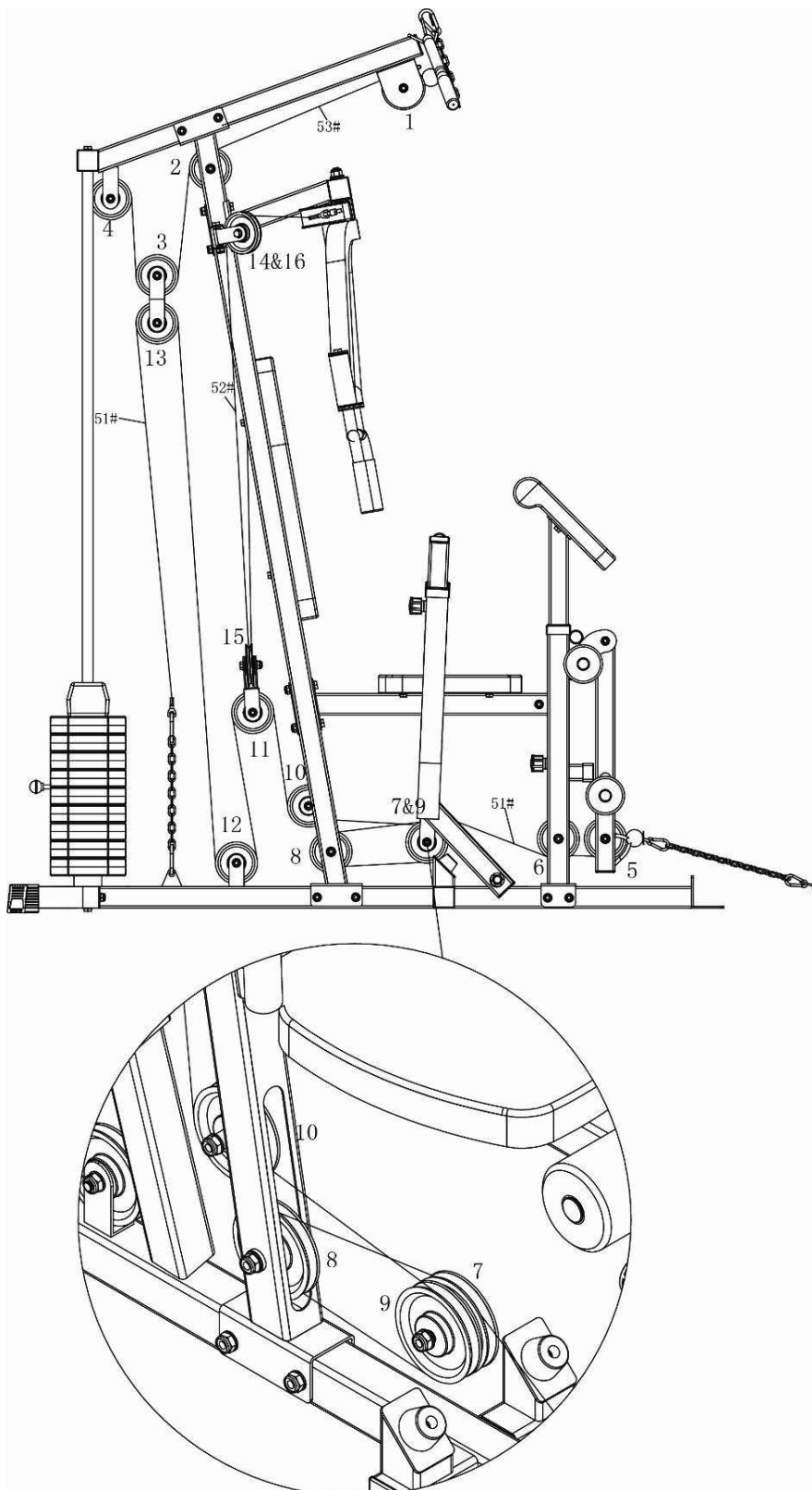

EXPLODED DRAWING

