



**USER MANUAL – EN**

**IN 8728 Motorized Treadmill inSPORTline T5000i**



**CONTENTS**

TIPS FOR SAFETY ..... 3

PACKING DETAILS ..... 4

EXPLODED VIEW ..... 5

PARTS LIST ..... 5

TREADMILL STRUCTURE ..... 7

INSTALLATION SKETCH..... 7

USE ..... 9

INSTRUCTIONS FOR CONSOLE..... 10

MAINTENANCE ..... 14

CLEANING ..... 16

CAUTIONS, DEPOSITING ..... 16

GUIDES FOR MALFUNCTION ..... 16

INSTRUCTION MANUAL FOR IRUNNING+ ..... 17

TERMS AND CONDITIONS OF WARRANTY, WARRANTY CLAIMS ..... 23

**Special tips:**

Before installation and operation, please read this operation manual carefully and save this manual for future reference.

**WARRANTY**

We make sure that this item is made of high quality materials.

In normal use, if any problem, we will take charge of maintenance.

The warranty time for this item is 24 months (from the day you buy it). If any quality problems about this item, please contact our service center within the 2 year period. Don't deal with quality problem by yourself without any authorization. The machine frame is warranted for 60 months.

If the product you purchased has problems as follows, the manufacturer's warranty is not effective:

- Improper operating, negligence, accident.
- Improper treatment when problems.
- Use the spare parts which are not from us.
- Damage from other reasons.

For easy-wear parts, we don't provide maintenance and replace for normal use, such as belt.

If you want to buy spare parts, please contact with our service and provide this manual.

**TIPS FOR SAFETY**

We have considered more for safety when we design and produce this item. However, in case of any unhappiness, please pay attention to these tips. We don't assume responsibility if any accident caused by follow tips.

- According to your health condition, please exercise properly. Overload or improper exercise will damage your health.
- While running, you should dress properly. Don't dress too loosely in case your clothes are entangled by the machine. And please wear sport shoes. Don't let your children or pet play near it to avoid unnecessary injury.
- This machine is not suitable for children. For patients or the disabled to use, they have to follow the guides by their guardians or doctors.
- Don't use this machine when in outdoor, high humidity condition or sun.
- Please pull the plug off from socket and keep the safe key, when the treadmill is unused.
- This machine is for suitable for professional exercise.
- The heart rate on this machine is not suitable for medical.
- If any damage for power wire, please ask manufacturer or professional service to replace it in case of any danger.
- Please check all the parts before using. Make sure that all the nuts or screws are fastened.
- Place your treadmill on the clean, flat and solid floor. Make sure that there is not anything pointy, water or hot near to the machine.
- Please stop exercising immediately and consult your doctor if you're feel giddy, surfeit, thorax ache or other symptoms.
- Make sure that hands are not near to running parts. Don't put your hands or foots under the running belt.
- When running this machine, it is only for one person to use it!
- Please use the spare parts from us, it is not acceptable if you use spare parts from others.
- This machine is SA level, max weight shall be less than 200 kg.
- Please consult your doctor at first before running, if you have one of the following diseases.

1. Cardiopathy, hypertension, sugar diabetes, respiratory disease, smoking, and other chronic diseases, complication disease.
2. If you are over 35 years old and heavier than common weight.
3. Women in pregnant or in breasting period.

### SPECIAL TIPS FOR SAFETY

- Please use qualified socket. If the plug and the socket is not compatible, please ask electrician to handle it and don't do anything for the plug.
- The voltage for this machine is 220V-240V AC.
- Don't let power wire touch roller, and also don't put power wire on the running belt. Don't use damaged plug.
- Before cleaning, moving and maintaining the machine, please pull off the plug for the socket.

**Warning: If don't pull off, it will cause injury or damage for the machine.**

WARNING! A system for monitoring heart rate may not be accurate. Overloading during training may cause serious injury or death. If you feel any discomfort, immediately stop the exercise!



### PACKING DETAILS

**Warning: Carefully install the product, avoid to make any damage.**



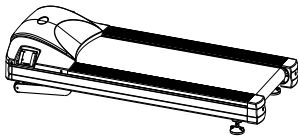
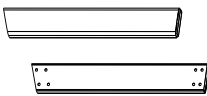
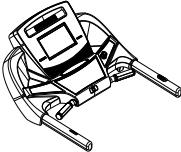

**Notice:**

- 1) Carefully read the instructions before installation. Operate in accordance with procedures.
- 2) Check components in the package
- 3) Remove all paper boxes and foams used as fasteners.

Check all the following components. If there is missing or problematic parts, please contact the dealer.

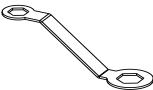
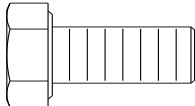
 <p>Frame</p>	 <p>Decorating cover at base</p>	 <p>Meter</p>	 <p>Hardware tool bag</p>
--	---	---	--

#### Hardware tool bag

 <p>Multi-wrench, 1pc</p>	 <p>Homemade wrench, 1pc</p>	 <p>Hexagon bolt M10*20, 8 pcs</p>
 <p>Washer, 8pcs</p>	 <p>Lubricant</p>	 <p>Safety key</p>
 <p>MP3 connector</p>		

## EXPLODED VIEW

These are all the components used in installation. All components are listed in the following form.

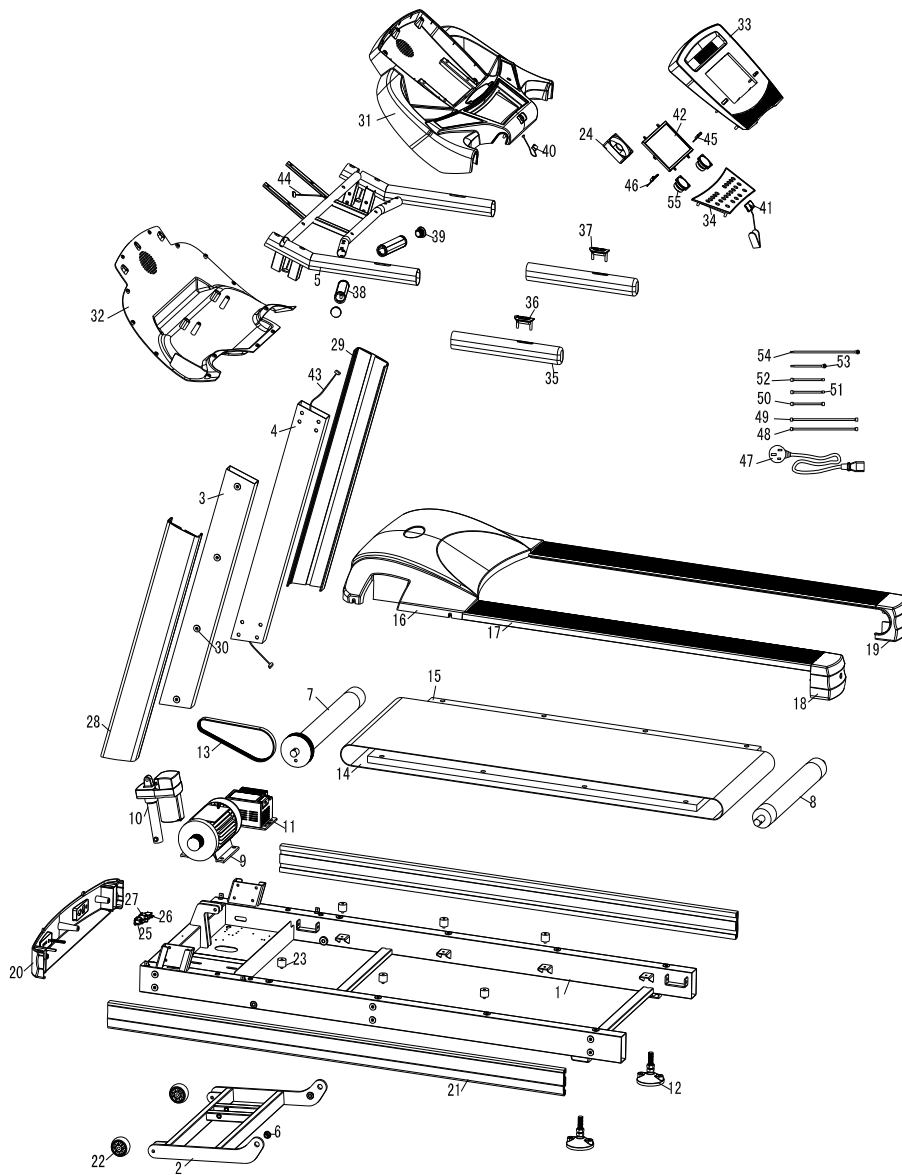

## PARTS LIST

No.	Component	Quantity
1	Frame	1
2	Incline frame	1
3	Left pillar accessory	1
4	Right pillar accessory	1
5	Dashboard frame	1
6	Tubular shaft for incline frame	2
7	Front roller	1

8	Back roller	1
9	AC motor	1
10	Incline motor	1
11	Inverter	1
12	Adjustable foot pad	2
13	Multislot belt	1
14	Running belt	1
15	Running board	1
16	Motor cover	1
17	Footplate	2
18	Left back cover	1
19	Right back cover	1
20	Front motor cover	1
21	Side decorative cover	2
22	Lifting transporting wheel	2
23	Shock absorption	6
24	Fan	1
25	"o" type socket	1
26	Overload protector	1
27	Power switch	1
28	Decorative cover for left meter tube	1
29	Decorative cover for right meter tube	1
30	Locating pad for decorative cover	28
31	Upper cover of meter	1
32	Lower cover of meter	1
33	Meter panel	1
34	Button panel	1
35	Sponge sheath	2
36	Incline button on handlebar	1
37	Speed buttons on handlebar	1
38	Heart rate sensor	2
39	Circular tube plug	2
40	Reed pipe for safety key	1
41	Safety key	1
42	Console board	1
43	Lower communication line	1
44	Upper communication line	1
45	MP3 module	1
46	USB/SD module	1
47	Power wire	1
48	Red connecting line	1

49	Green connecting line	1
50	Red connecting line	1
51	Red connecting line	1
52	Green connecting line	1
53	Yellow/Green ground line	1
54	Yellow/Green ground line	1
55	Speaker	2

## TREADMILL STRUCTURE

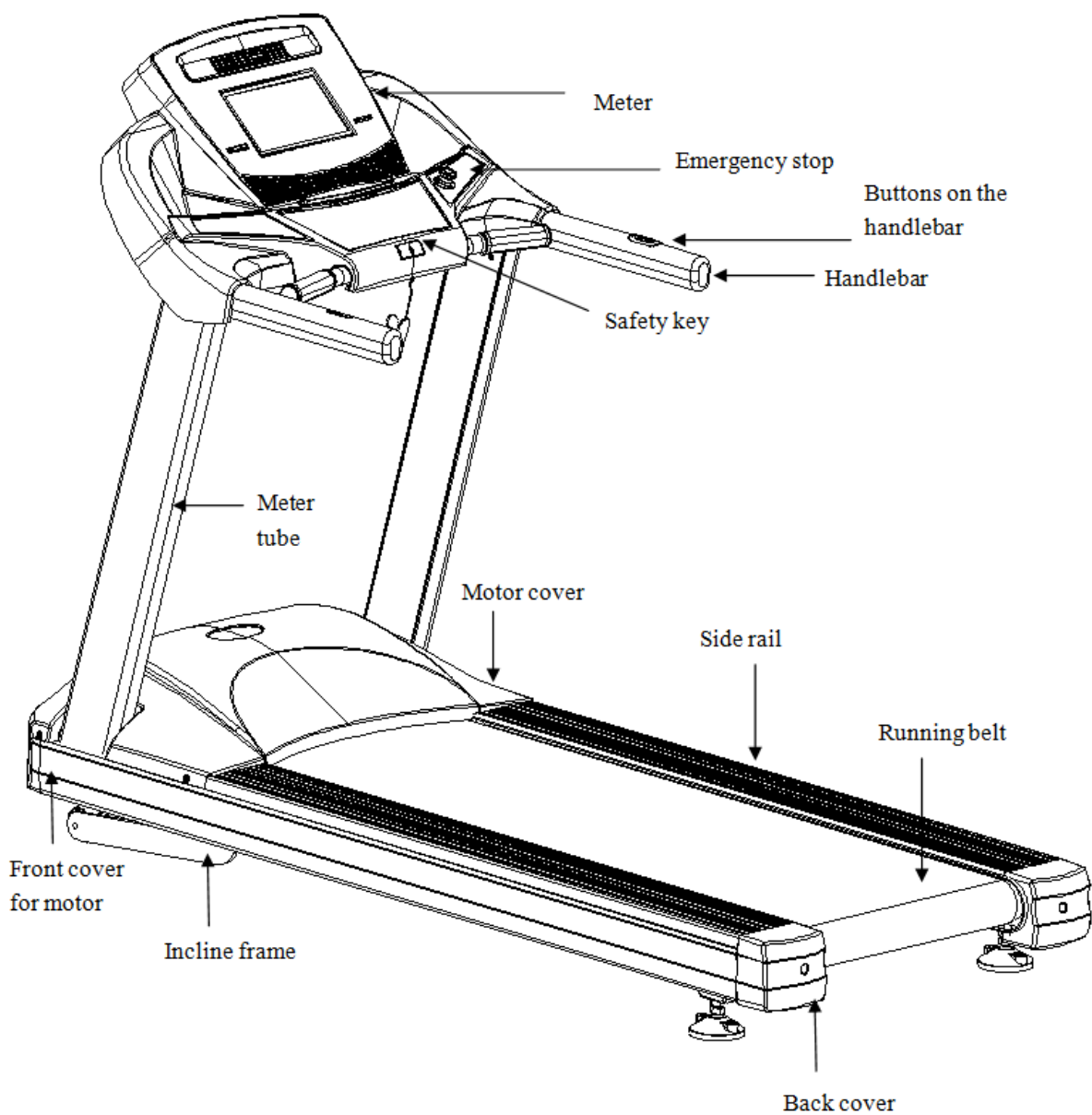

## INSTALLATION SKETCH

**Step 1:** Remove the motor cover

Remove the screws

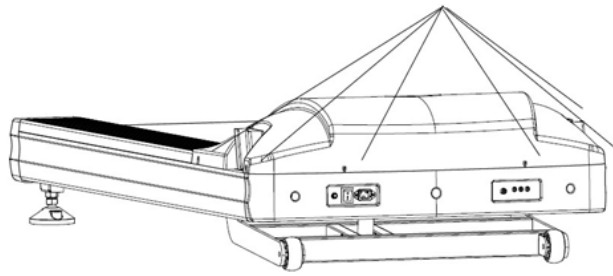

**Step 2:** Set meter tubes on the frame

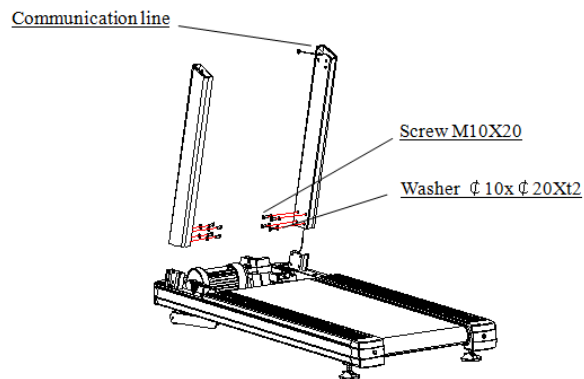

- Let the communication line pass through the meter tube.
- Set meter tubes on the frame, use 8 pcs of M10\*20 screw and 8 pcs of washer to solid the meter tubes. (Don't fasten screw at first).

**Step 3:** Put meter on the meter tube

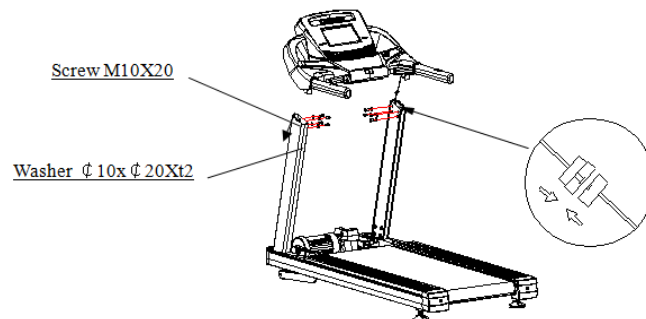

- Make sure that communication lines are connected correctly.
- Put meter on the meter tube, use 8 pcs of Screw M10\*20 with 8 pcs of washer to solid the meter. (Don't fasten screw at first).
- Make the machine power on, push "Start", if everything goes well, then fasten screws mentioned in front steps.



**Step 4:** Install the motor cover



## USE

Insert the power plug into the socket and switch on the machine. The switch light will be on and you will hear a voice “Di”. You will find the meter light will also be on.

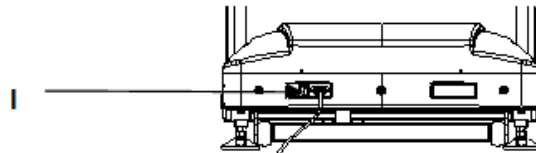

## SAFETY KEY

The machine can work only when you put safety key at the appointed position. Make sure the other end of the safety key has been nipped to your clothes. In this way, you can pull the safe key for the machine's sudden stop under the dangerous condition. Then you will not be injured. If you need to reuse the machine, you could put safety key back.



## INSTRUCTIONS FOR CONSOLE



## TECH INFO

<b>Time</b>	<b>00:00-99:59 min</b>	
<b>Speed</b>	<b>1.0-22.0 km/h</b>	
<b>Incline</b>	<b>0-22%</b>	
<b>Distance</b>	<b>0.00-99.9 km</b>	
<b>Calorie</b>	<b>0-999 KCAL</b>	
<b>Heart rate</b>	<b>40-250 / Min</b>	
<b>Program</b>	<b>Preset program</b>	<b>P1-P99</b>
	<b>User-defined program</b>	<b>U1.U2.U3</b>
	<b>Body Fat</b>	<b>BODY FAT</b>
	<b>Heart rate control</b>	<b>HRC</b>

## PANEL KEYS AND FUNCTIONS

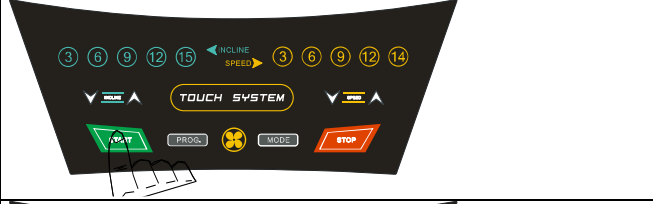
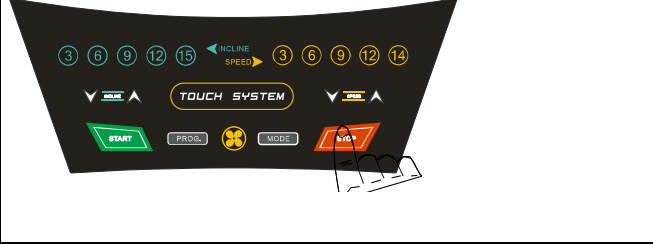
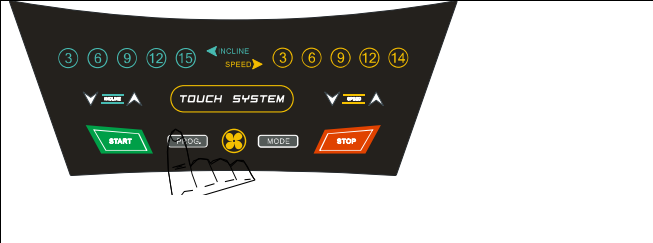
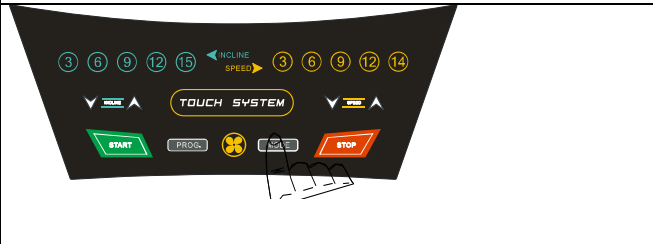
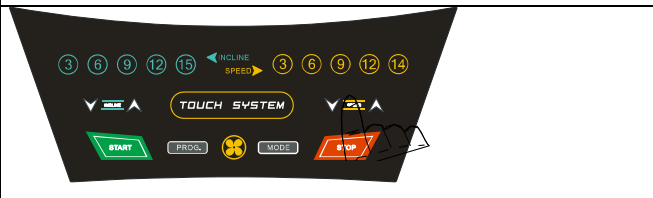
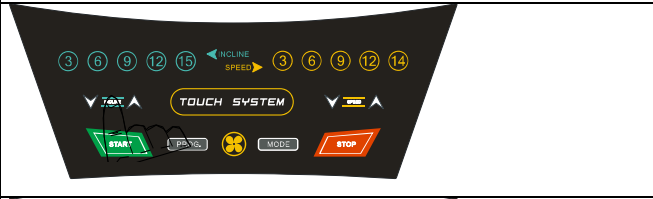
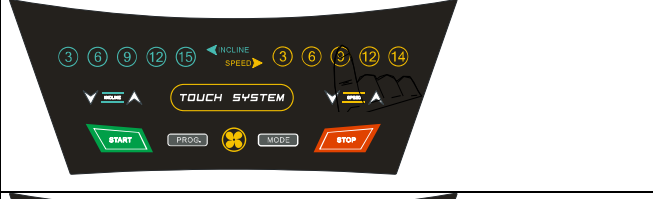
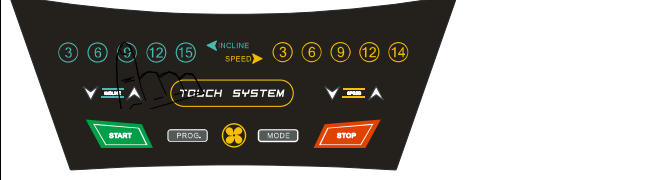
	<p><b>START Key:</b> Press "Start" key, there will be 3 seconds countdown displayed on the window! After countdown, the machine will run at the speed of 1.0km/h.</p>
	<p><b>STOP Key:</b> Under running condition, press "Stop" key, it will slow down then stop.</p> <p><b>Reset:</b> Press "Stop" key for a long time, the machine will be reseted and start for new exercise record when you press "Start".</p>
	<p><b>PROG. Key</b> Under ready condition, Press "PROG.", you could select program P1-P99, U1-U3 and BODY FAT.</p> <p>P1-P99 is preset program, U1-U3 is user-defined program, BODY FAT is body fat test.</p> <p>When you finished selecting, you have to press "Start" to start it!</p>
	<p><b>MODE Key</b> Under ready condition, press "MODE", you could select 15:00, 1.0 or 50.</p> <p>15:00 is time countdown, 1.0 is distance countdown, 50 is calorie countdown.</p> <p>When you have selected, you have to press "Start" to start it!</p>
	<p><b>SPEED + - Key</b> Under ready condition, it is used for setting some data. Under running condition, it is used for setting speed, speed difference is 0.1 km/h for each time. When we press it for above 0.5 seconds, it will progressive increase or reduce automatically.</p>
	<p><b>INCLINE <math>\Delta</math> <math>\nabla</math> Key</b> Under ready condition, it is used for setting some data. Under running condition, it is used for setting incline, incline difference is 1% for each press. When we press it for above 0.5 seconds, it will progressive increase or reduce automatically.</p>
	<p><b>SPEED direct key</b> Use these keys, you could set speed for 3 km/h, 6km/h, 9km/h, 12km/h, 14km/h directly.</p>
	<p><b>INCLINE direct key</b> Use these keys, you could set incline for 3% , 6% , 9% , 12%, 15% directly.</p>

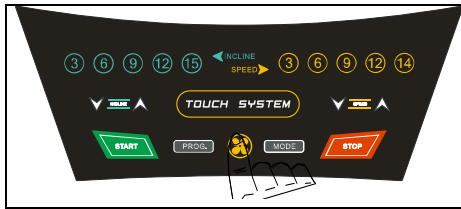

**FAN**  
Use this key to turn on or turn off the fan.

## DISPLAYED WINDOW

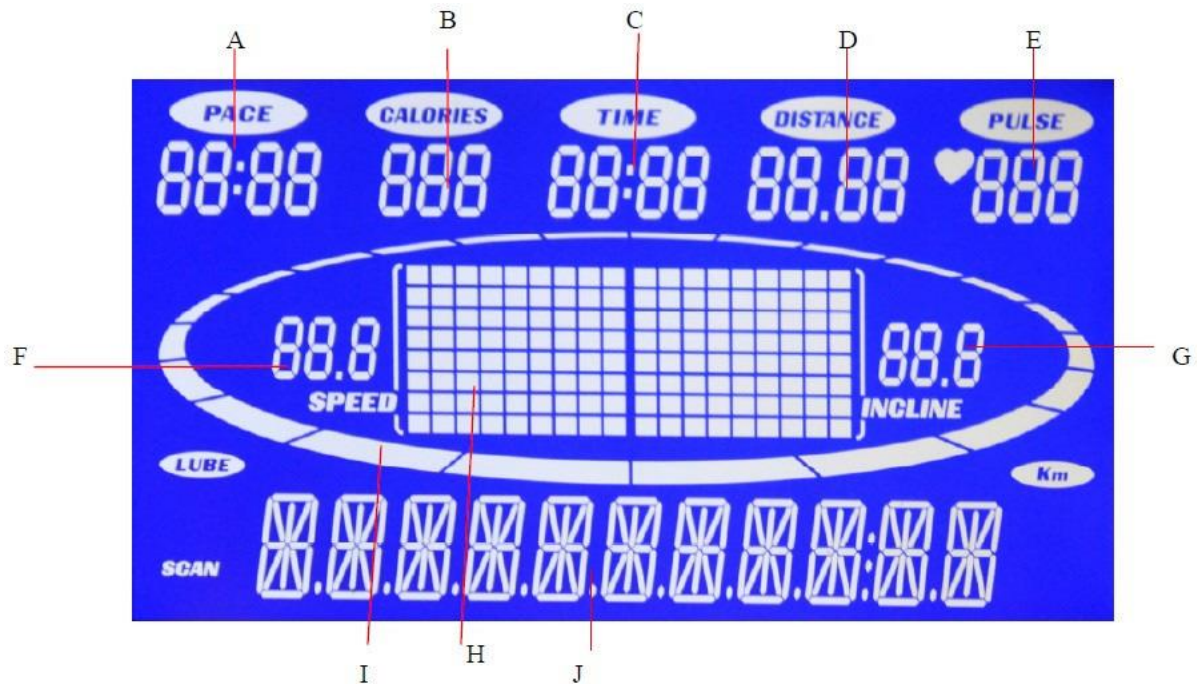

A	PACE: Display the time rate;
B	CALORIES: Display running calories
C	TIME: Display running time
D	DISTANCE: Display running distance
E	PULSE: Display running heart rates; Display P1-P99, U1-U3, HRC
F	SPEED: Display running speed
G	INCLINE: Display running incline
H	Display program picture
I	Display runway and number of turns; DIST: Display running distance; BMI: Display body fat test data;
J	SCAN: Display following warning words; Display BODYFAT; Display SEG, MAN, WOMAN, AGE, WEIGHT, HEIGHT

## DETAILED INSTRUCTIONS

### Quick Start (for manual mode)

- Turn on power switch, put safe key in the right position.
- Press “Start” key, there will be 3 seconds countdown displayed on the window! After countdown, the machine will run at the speed of 1.0km/h.

- According to your needs, you could use “SPEED+”, “SPEED-” to change speed, use “INCLINEΔ”, “INCLINE∇” to change incline.
- When you put your hands on the handlebar’s heart pulse for 5-8 seconds, it will display heart rate on the screen.

### Manual Mode

- Under ready condition, Press "Start" key, the machine will run at the speed of 1.0km/h and incline 0%. The other window will forward count from 0. Press “INCLINE direct key, “SPEED direct key”, “INCLINEΔ”, “INCLINE∇”, “SPEED+”, “SPEED-”, you could change speed and incline.
- Under ready condition, press “MODE” to come into time countdown mode. Window “Time” displays “15:00” and shining, you could press “INCLINEΔ”, “INCLINE∇”, “SPEED+”, “SPEED-” to set exercise time from 5:00-99:00.
- When on distance countdown mode, press “MODE” to enter. Window “DIST” displays “1.0” and shining, you could press “INCLINEΔ”, “INCLINE∇”, “SPEED+”, “SPEED-” to set exercise distance from 0.5-99.9.
- When on calorie countdown mode, press “MODE” to enter. Window “CAL” displays “50” and shining, you could press “INCLINEΔ”, “INCLINE∇”, “SPEED+”, “SPEED-” to set calorie from 10-999.
- After finish setting time, distance or calorie mode, you could press “Start” to start the machine. There will be 3 seconds countdown displayed on the window! After countdown, the machine will run at the speed of 1.0km/h. You could press “INCLINEΔ”, “INCLINE∇”, “SPEED+”, “SPEED-” to adjust speed and incline. Press “Stop”, the machine will stop slowly.

### Preset Program

There are 99 built-in programs P1-P99, Under ready condition, press “PROG.” key continuously, window “PULSE” will display “P1-P99”, U1-U3. Window “SCAN” will display HRC, BODYFAT. P1-P99 are built-in programs. After selecting specific program, Window “Time” are shining and displaying “10:00” and shining, you could press “INCLINEΔ”, “INCLINE∇”, “SPEED+”, “SPEED-” to set exercise time from 5:00-99:00. After setting, press “Start” to start the machine. Built-in programs have 18 parts, the time for each part = setting time / 18. When machines come into next part, there will be a voice “Bi-Bi- Bi” for 3 times to remind you, and speed and incline will be changed according to the built-in programs. No matter whether you have pressed “INCLINEΔ”, “INCLINE∇”, “SPEED+”, “SPEED-” to change speed and incline in front parts. After finishing one program, there will be voice “Bi- Bi-Bi” for 3 times, the machine stops slowly and “End” will be displayed on the window. 5 seconds later, the machine will come into ready condition.

### User-defined Program

#### Setting for user-defined program:

Under ready condition, press “PROG.” key continuously, window “PULSE” will display “P1-P99”, U1-U3. Window “SCAN” will display HRC, BODYFAT. U1-U3 are user-defined program. After selecting U1 or U3, press “MODE” to set, “SPEED+”, “SPEED-” to set speed, “INCLINEΔ”, “INCLINE∇” to set incline. After setting, press “MODE” key to finish one part and come into next part. After finishing setting for 18 parts, press “Start” to start the machine. User-defined program will be kept in the machine forever unless you reset them. These data can’t be lost even outage.

#### Special explain:

Every mode has 18 parts. You can only press “Start” key to start the machine after finishing all parts’ setting and total exercise time setting.

#### Data range:

Parameter	Setting range	Displayed range
Time (minute:second)	5:00-99:00	0:00-99:59
Incline (%)	0-22	0-22
Speed (KM/H)	1.0-22	1.0-22
Distance (KM)	0.5-99.9	0.00-99.9
Heart rate (time/minute)	N/A	40-250
Calorie (cal)	10-999	0-999

## Body Fat Test

Under ready condition, press "PROG." key continuously to come into BODYFAT. Press "MODE" key, you could find "F-1-SEX", "F-2-AGE", "F-3-HEIGHT", "F-4-WEIGHT", "P"-BODYFAT" displayed on the window. Press "SPEED+", "SPEED-" to set. After setting, press "MODE" to come into "BODYFAT". At this time, put your hand on the heart pulse for 5-8 seconds, there will be body fat date displayed on the window. You could find whether your weight and height matches. (This data only for reference, can't be used for medical data)

F-1	SEX	MAN	WOMAN
F-2	AGE	10-----99	
F-3	HEIGHT	100----240	
F-4	WEIGHT	20-----160	
P	BODYFAT	≤19	Underweight
	BODYFAT	=(20---25)	Normal weight
	BODYFAT	=(25---29)	Overweight
	BODYFAT	≥30	Obesity

## HRC Program

1. When you want to use HRC program, please wear chest belt.
2. Under ready condition, press "PROG." key, window displays HRC. At this time, press "MODE" key, there will be some displays as below: AGE: 30. You could use "SPEED +-" key to set the age (from 15-80). After setting press "MODE", there will be THR: specific heart rate displayed on the window and shining, you could use "SPEED +-" key to set the heart rate (from 90-120). Press "MODE" again, there will be Time: 10 displayed on the window and shining, you could use "SPEED +-" key to set the time (10-99).
3. After setting all of them, you could press "START" key to run the machine.
4. Now, you could use chest belt or heart rate sensor on the handlebar to test the heart rate. If you use both of them, our system will choose the chest belt.
5. Special Tips: From the safety side, we suggest the maximum speed to be 10 km/h when on HRC program.

## Power Save Mode

Our machine has power save function. When you turn on power switch for 10 minutes and don't press any key, the machine will come into power save mode and there is no light on the screen. You could press any key into ready condition.

## MAINTENANCE

### Identification ways for the degree of tightness of running belt and poly V-belt.

When the running belt skips, please follow the steps as follows to make sure which belt needs to be adjusted, running belt or poly V-belt.

- a) Unplug all power supply, screw and remove the Base cover.
- b) Turn the speed to be around 3km/h, step on the running belt by pressure and try your best to make the running belt stop. If running belt stops, together with the front roll, but the motor still runs, under this condition, it means the poly V-belt needs to be adjusted.
- c) Turn the speed to be around 3km/h, step on the running belt by pressure and try your best to make the running belt stop. If running belt stops, but front roll still runs, under this condition, it means the running belt needs to be adjusted.

### The adjustment steps for poly V-belt

- a) Unplug all power supply and take off the base cover.
- b) Loosen the four screws for the motor, adjust the V-belt tension bolts in clockwise direction, and then tighten back the four screws for the motor.

### Adjustment running belt

- a) Turn the speed to be 6km/h for running.
- b) Turn the both tension screws located at the end of the treadmill on the right and left sides, half a turn clockwise using the Allen key. (Diagram1 and Diagram 2)
- c) After adjustment, running belt still slips; please repeat the steps as above.

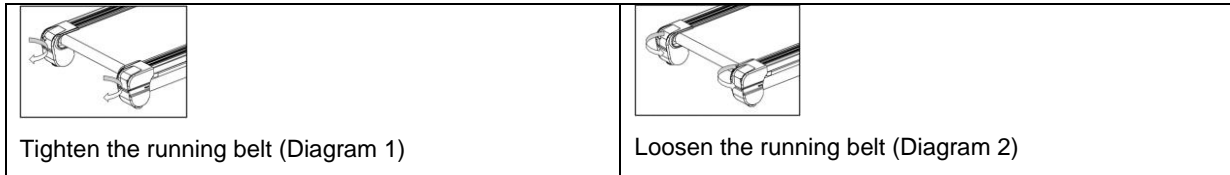

### The adjustment steps for running belt deflection

The running belt will be deflected more or less under using. Then it needs to be adjusted. The steps are as follows:

- a) Place the treadmill on a horizontal floor, turn the speed to be 6 km/h for running.
- b) If the running belt is deflected to the right, adjust the bolt on the right by turning it for half a turn clockwise, then adjust the bolt on the left by turning it half an anti-clockwise.(see Diagram 3)
- c) If the running belt is deflected to the left, adjust the bolt on the left by turning it for half a turn clockwise, then adjust the bolt on the right by turning it half a turn anti-clockwise.(see Diagram 4)
- d) After the adjustment, the running belt still keeps deflecting, please repeat the steps above.

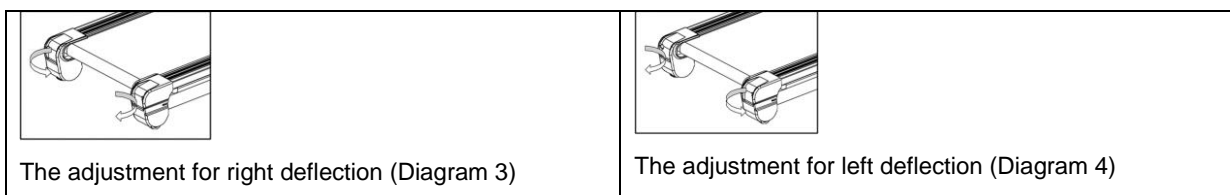

### Running board lubrication- Silicone oil has been provided (White Bottle)

The treadmill is brand-new and has been pre-factory lubricated. Lubrication is not necessary directly after purchase.

Lubrication needs constant maintenance termly after purchase. The friction between the running board and running belt has a great effect on the treadmills' life. So please lubricate your machine termly (every one month).

#### The steps are as follows:

**Step 1.** Please unplug power supply for the treadmill and loosen the belt (Belt tension screw located at the end of the treadmill).

**Step 2.** After loosening the screw, lift up the running belt and clean in-between the running board. Squeeze the small white bottle of SILICONE oil which was supplied with your purchase and wipe it evenly across the board.

**Step 3.** After lubricating the board, screw the belt tension back to its correct tension. Tighten evenly on both sides. When it is almost tensioned, run the treadmill at 1km without any load. Adjust both tension screws to make the belt in the centre of the back roller. Run the treadmill at 5km for 3mins.

**Step 4.** Stop the treadmill and start to walk on it at 5km/h. Lastly fine tension both screws until it's running smoothly with your weight on.

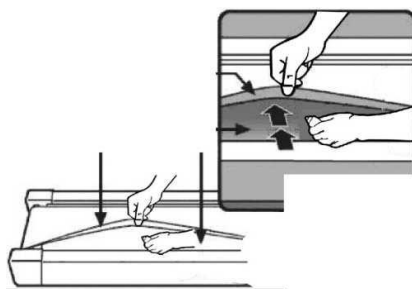

## CLEANING

- Please power off and pull the plug out before cleaning.
- Wipe out the dust stuck on the surface and running board frequently.
- Please clean the surface of frame and running belt with a soft cloth dipped with suds, don't use things like eradicator and naphtha. (After cleaning, please dry it for use)
- Please take the protecting cover off every two month, use vacuum dust-collector to suck the dust remaining inside of the protecting cover. (The dust will make the components of circuitry board short circuit)

## CAUTIONS, DEPOSITING

### Cautions

Please make sure that the plug has been pulled out before cleaning or maintenance.

### Depositing

The treadmill should be deposited indoor in case of being damp. Water can't be spattered and nothing can be laid and inserted on the treadmill.

Please keep the air a little humid in winter. And please void the big static electricity, it may disturb the operation of meters or even damage them.

## GUIDES FOR MALFUNCTION

### Analyzing and eliminating malfunction

Item.	Malfunction	Reasons	Solution
1	Treadmill can't be started	The safe key isn't in the right position	Put the safe key in the right position
		The electrical switch is placed to "0"	Turn the electrical switch to "1"
2	Meter can't display	Check the machine whether it is in power	Check the power cord are connected well and switch on
		The upper communication is broken	Replace it!
		The meter and upper communication line are not connected well	Disassembly meter and check the upper communication line, make sure that meter and communication line are connected well.
3	Heart rate can't be displayed	The pole of heart rate sensor is not wet enough	Wet the pole with water or liquor for hard contact lenses
		Disturbed by electromagnetism	Stay away from electromagnetism



4	Incline doesn't work	The motor wire is not well connected	Open the motor cover and reconnect it
5	Running belt runs faster or slower than what has been displayed	Unadjusted	Readjust it
6	Running belt slips	Running belt is not tight enough	Please read point 6.3 Adjustment steps for tightening running belt for reference
7	Running belt is deflected	The running belt is unadjusted.	Please read point 6.4 The steps for adjusting the deflected running belt for reference
8	Displayed E01 on the screen	The sensor wire or motor are broken	Remove the motor cover and change the sensor wire, motor in return
9	Displayed E02 on the screen	Over power voltage protection	Use normal voltage.
10	Displayed E03 on the screen	Over current protection	Check whether it is overloading
			Check whether the drive motor can run normally. If not, replace motor.
11	Displayed E04 on the screen	The motor is not in power	The motor wire are not connected well or the motor are broken
12	Displayed E06 on the screen	Connection error	Changing the upper or lower connection line
13	Displayed E09 on the screen	Incline error	The incline motor wire are not connected well or the incline motor are broken
14	Displayed E0P on the screen	Speed error	Setting parameter wrong or sensor wire broken
15	Displayed E0C on the screen	Short-circuit protection	PCB MOS broken or motor broken
16	Displayed E07 on the screen	Safety key off	Put safety key on the meter or change the safety key or reed pipe for safety key
17	Displayed E0E on the screen	Eeprom error	Upper or lower communication line broken or PCB broken

If you still can't solve the problems after taking the solutions above, we hope that you can contact our dealer or company as soon as possible.

## INSTRUCTION MANUAL FOR IRUNNING+

### 1. Download iRunning to tablet

APP name: [iRunning+] on Google play/iTune Store

### 2. Connect the console to tablet

#### 2.1 iOS system:

Enable Bluetooth function and search device [iRunningXXX] (Note: Please find the device no. from the console). Then perform [Bluetooth pairing device], preset pairing password 0000 (4 zeros).



After pairing, go to desktop and click  to enter APP.

#### 2.2 Android system:





Enter iRunning → Click  to scan device → select device [iRunningXXX]

(Note: Please find the device no. from the console). Then perform [Bluetooth pairing device], preset pairing password 0000 (4 zeros).

### 3. Programs introduction

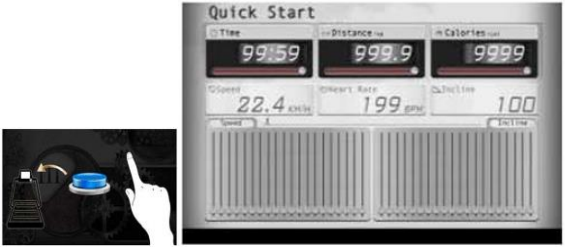

#### 3.1 Quick Start

Start	Stop	Workout information
		

Start exercise directly. During exercise, user can adjust Speed/Incline by pressing console buttons (Speed/Incline adjustment as following). After exercise, user can share workout information via Facebook or Twitter or else go back to Homepage.

##### 3.1.1 Incline adjustment drawing:

User may adjust the treadmill incline by pressing UP/DOWN key or hot keys.

Adjust range: 0~15

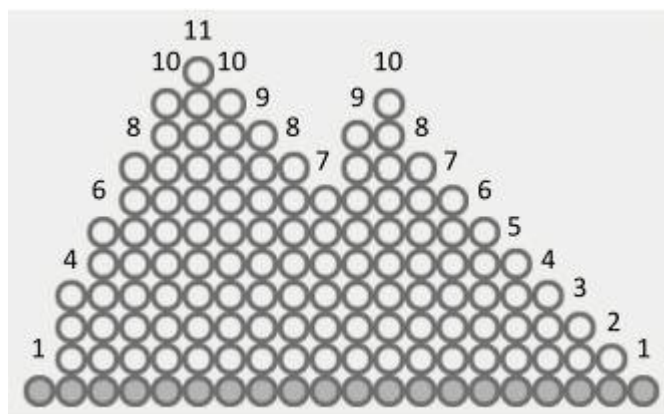

##### 3.1.2 Speed adjustment drawing:

User may adjust training speed by pressing UP/DOWN key or hot keys.

Adjust range: 1~18

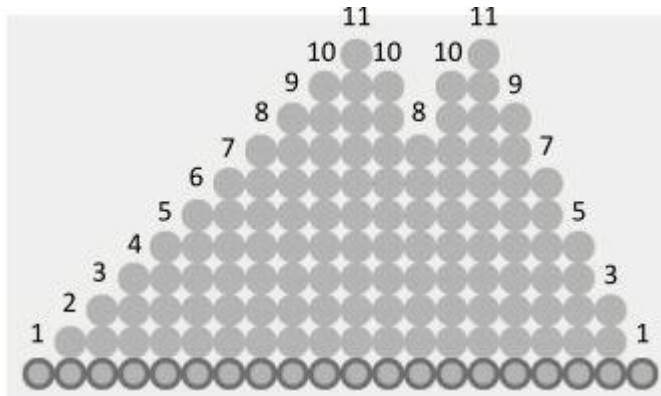



**Warning:** During any exercise, if turn on the safety switch, treadmill will pause immediately and show the Warning page; If turn off the safety switch, system will stop current exercise and go to work-out summary page.

Warning page:

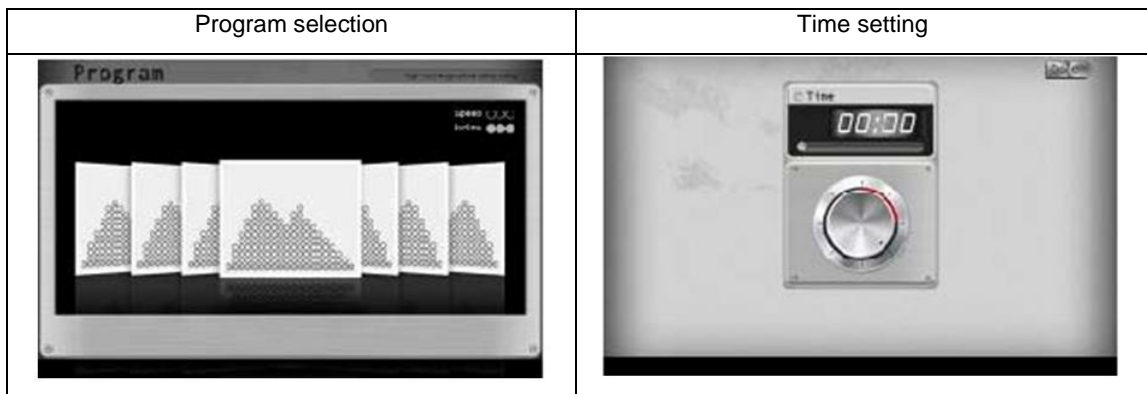

### 3.2 Program



User can select from P1 to P20 for training. After selection, set training time and press  to start. During exercise, user can adjust Speed\Incline by p pressing console buttons. After exercise, user can share workout information via Facebook or Twitter or else go back to Homepage.

### 3.3 Manual

Setting page:



User can set target Time/Distance/Calories by manual. After setting, press **Done** to start. During exercise, user can adjust Speed/Incline by pressing console buttons. After exercise, user can share workout information with Facebook or Twitter or else go back to Homepage.

### 3.4 User Program

Setting page	Program cluster	Time setting

User can design his/her own training graph by adjusting Speed/Incline value and then name the program for future reference. From the program cluster, user may add or delete program. When entering program, set time and press start. During exercise, user can an adjust Speed/Incline by pressing console buttons. After exercise, user can share workout information with Facebook or Twitter or else go back to Homepage.

### 3.5 HRC

HR selecting	Custom HR Setting	Exercise page

In this mode, user can choose: 55%, 65%, 75%, custom for different heart rate training. For example, user chooses 55%, system will self-calculate Heart Rate:  $(220 - \text{Age}) * 55\% = 103.4 \text{ BPM}$ . After selection, double click the icon to enter to enter the program. Then set time and press **Done** to start. By pressing Custom, user can set target HR. System max.BPM is 230. When Time counts down to 0 from set value, console will stop and treadmill stop as well, then comes to workout page.

## Warm up Reminder



When exercise start, there is 2 minutes Warm up time. If no hand pulse input, system will alarm and remind user to grip handlebar. Without pulse input for 30 seconds, console will stop.

## 4. Personal Setting

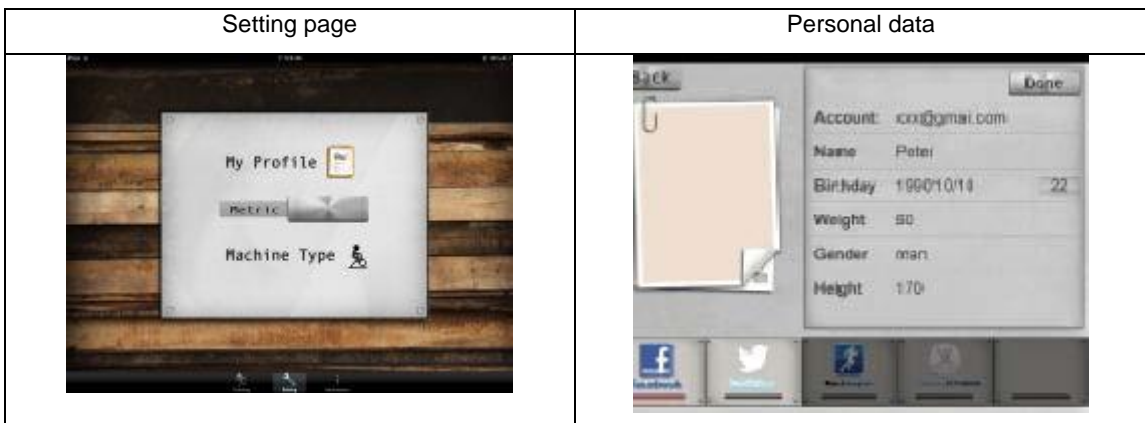

User may set personal profile by entering [Setting] and select Metric or Imperial. After setting personal data, it can be saved for future reference.

## 5. Workout Information

History record:



From the Information center, user can review history workout record.

## 6. GYM Center – i-Route

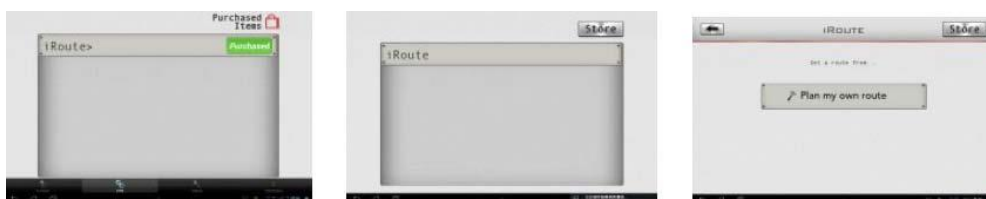

Select



to plan training route. Set Start location by first long press and End location by second long press. After planning the route, press  to start training.

Start location	End location	Training page



During exercise, user may click  to choose monitor routes by Map view/Satellite view/Street view mode.

Map view	Satellite view

i-Route multiple turning points:



Method: Firstly set Start and End location. Then get the first turning point by one click. You can totally set 8 turning points. System will plan the route again after your setting.

## **7. APP Supported Devices**

### 7.1 Supported mobile devices:

- Android: 1280\*752 Android 4.0 tablet (only for 10 inch above)
- i-OS: 5.0 or above, iPad4, iPad3, iPad2, iPad, iPad Mini

### 7.2 Work with machine type: SD8710 console and treadmill

## **TERMS AND CONDITIONS OF WARRANTY, WARRANTY CLAIMS**

### **General Conditions of Warranty and Definition of Terms**

All Warranty Conditions stated hereunder determine Warranty Coverage and Warranty Claim Procedure. Conditions of Warranty and Warranty Claims are governed by Act No. 40/1964 Coll. Civil Code, Act No. 513/1991 Coll., Commercial Code, and Act No. 634/1992 Coll., Consumer Protection Act, as amended, also in cases that are not specified by these Warranty rules.

The seller is SEVEN SPORT s.r.o. with its registered office in Borivojova Street 35/878, Prague 13000, Company Registration Number: 26847264, registered in the Trade Register at Regional Court in Prague, Section C, Insert No. 116888.

According to valid legal regulations it depends whether the Buyer is the End Customer or not.

“The Buyer who is the End Customer” or simply the “End Customer” is the legal entity that does not conclude and execute the Contract in order to run or promote his own trade or business activities.

“The Buyer who is not the End Customer” is a Businessman that buys Goods or uses services for the purpose of using the Goods or services for his own business activities. The Buyer conforms to the General Purchase Agreement and business conditions to the extent specified in the Commercial Code.

These Conditions of Warranty and Warranty Claims are an integral part of every Purchase Agreement made between the Seller and the Buyer. All Warranty Conditions are valid and binding, unless otherwise specified in the Purchase Agreement, in the Amendment to this Contract or in another written agreement.

### **Warranty Conditions**

#### Warranty Period

The Seller provides the Buyer a 24 months Warranty for Goods Quality, unless otherwise specified in the Certificate of Warranty, Invoice, Bill of Delivery or other documents related to the Goods. The legal warranty period provided to the Consumer is not affected.

By the Warranty for Goods Quality, the Seller guarantees that the delivered Goods shall be, for a certain period of time, suitable for regular or contracted use, and that the Goods shall maintain its regular or contracted features.

#### **The Warranty does not cover defects resulting from:**

User's fault, i.e. product damage caused by unqualified repair work, improper assembly, insufficient insertion of seat post into frame, insufficient tightening of pedals and cranks

Improper maintenance

Mechanical damages

Regular use (e.g. wearing out of rubber and plastic parts, joints etc.)

Unavoidable event, natural disaster

Adjustments made by unqualified person

Improper maintenance, improper placement, damages caused by low or high temperature, water, inappropriate pressure, shocks, intentional changes in design or construction etc.

### **Warranty Claim Procedure**

The Buyer is obliged to check the Goods delivered by the Seller immediately after taking the responsibility for the Goods and its damages, i.e. immediately after its delivery. The Buyer must check the Goods so that he discovers all the defects that can be discovered by such check.

When making a Warranty Claim the Buyer is obliged, on request of the Seller, to prove the purchase and validity of the claim by the Invoice or Bill of Delivery that includes the product's serial number, or eventually by the documents without the serial number. If the Buyer does not prove the validity of the Warranty Claim by these documents, the Seller has the right to reject the Warranty Claim.

If the Buyer gives notice of a defect that is not covered by the Warranty (e.g. in the case that the Warranty Conditions were not fulfilled or in the case of reporting the defect by mistake etc.), the Seller is eligible to require a compensation for all the costs arising from the repair. The cost shall be calculated according to the valid price list of services and transport costs.

If the Seller finds out (by testing) that the product is not damaged, the Warranty Claim is not accepted. The Seller reserves the right to claim a compensation for costs arising from the false Warranty Claim.

In case the Buyer makes a claim about the Goods that is legally covered by the Warranty provided by the Seller, the Seller shall fix the reported defects by means of repair or by the exchange of the damaged part or product for a new one. Based on the agreement of the Buyer, the Seller has the right to exchange the defected Goods for a fully compatible Goods of the same or better technical characteristics. The Seller is entitled to choose the form of the Warranty Claim Procedures described in this paragraph.

The Seller shall settle the Warranty Claim within 30 days after the delivery of the defective Goods, unless a longer period has been agreed upon. The day when the repaired or exchanged Goods is handed over to the Buyer is considered to be the day of the Warranty Claim settlement. When the Seller is not able to settle the Warranty Claim within the agreed period due to the specific nature of the Goods defect, he and the Buyer shall make an agreement about an alternative solution. In case such agreement is not made, the Seller is obliged to provide the Buyer with a financial compensation in the form of a refund.



**SEVEN SPORT s.r.o.**

Sídlo: Bořivojova 35/878, 130 00, Praha 3, ČR  
Centrála: Dělnická 957, 749 01 Vítkov  
Reklamace a servis: Čermenská 486, 749 01 Vítkov

IČO: 26847264  
DIČ: CZ26847264  
Telefon: +420 556 300 970  
Mail: eshop@insportline.cz  
reklamace@insportline.cz  
servis@insportline.cz  
Web: www.insportline.cz

---

**SK**

**inSPORTline s.r.o.**

Centrála, reklamácie, servis: Električná 6471, 911 01 Trenčín, SK

IČO: 36311723  
DIČ: SK2020177082  
Telefón: +421(0)326 526 701  
Mail: objednavky@insportline.sk  
reklamacie@insportline.sk  
servis@insportline.sk  
Web: www.insportline.sk

Date of Sale:

Stamp and Signature of Seller: