



**USER MANUAL – EN**

**IN 9126 Motorized Treadmill inSPORTline T60i**



# CONTENTS

- SAFETY INSTRUCTIONS ..... 3
- PACKING DETAILS ..... 4
- EXPLODED VIEW ..... 5
- LIST OF COMPONENTS ..... 5
- TREADMILL STRUCTURE ..... 6
- ASSEMBLY INSTRUCTIONS..... 7
- USAGE ..... 8
  - POWER SWITCH ..... 8
  - SAFETY KEY ..... 8
  - FOLDING & UNFOLDING ..... 9
- INSTRUCTION FOR CONSOLE ..... 10
  - DETAILED INSTRUCTIONS ..... 13
- MAINTENANCE ..... 14
  - RUNNING BELT ADJUSTMENTS ..... 14
  - CLEANING ..... 16
  - CAUTIONS, DEPOSITING ..... 16
- GUIDES FOR MALFUNCTION ..... 16
- INSTRUCTION MANUAL FOR IRUNNING+ ..... 18
- TERMS AND CONDITIONS OF WARRANTY, WARRANTY CLAIMS ..... 23

**Special tips:**

Before installation and operation, please read this operation manual carefully and save this manual for future reference.

**SAFETY INSTRUCTIONS**

We have considered more for safety when we design and produce this item. However, in case of any unhappiness, please pay attention to these tips. We don't assume responsibility if any accident caused by follow tips.

- According to your health condition, please exercise properly. Overload or improper exercise will damage your health.
- While running, you should dress properly. Don't dress too loosely in case your clothes are entangled by the machine. And please wear sport shoes. Don't let your children or pet play near it to avoid unnecessary injury.
- This machine is not suitable for children. For patients or the disabled to use, they have to follow the guides by their guardians or doctors.
- Don't use this machine when in outdoor, high humidity condition or sun.
- Please pull the plug off from socket and keep the safe key, when the treadmill is unused.
- This machine is for home use, not suitable for professional exercise or testing, and also not suitable for medical purpose.
- The heart rate on this machine is not suitable for medical.
- If any damage for power wire, please ask manufacturer or professional service to replace it in case of any danger.
- Please check all the parts before using. Make sure that all the nuts or screws are fastened.
- Place your treadmill on the clean, flat and solid floor. Make sure that there is not anything pointy, water or hot near to the machine.
- Please stop exercising immediately and consult your doctor if you're feel giddy, surfeit, thorax ache or other symptoms.
- Make sure that hands are not near to running parts. Don't put your hands or foots under the running belt.
- When running this machine, it is only for one person to use it!
- Please use the spare parts from us, it is not acceptable if you use spare parts from others.
- This machine is HC level, max weight shall be less than 150 kg.
- Please consult your doctor at first before running, if you have one of the following diseases.
  1. Cardiopathy, hypertension, sugar diabetes, respiratory disease, smoking, and other chronic diseases, complication disease.
  2. If you are over 35 years old and heavier than common weight.
  3. Women in pregnant or in breasting period.

**SPECIAL TIPS FOR SAFETY**

- Please use qualified socket. If the plug and the socket is not compatible, please ask electrician to handle it and don't do anything for the plug.
- The voltage for this machine is 220V-240V AC.
- Don't let power wire touch roller, and also don't put power wire on the running belt. Don't use damaged plug.

- Before cleaning, moving and maintaining the machine, please pull off the plug for the socket.





**Warning: If don't pull off, it will cause injury or damage for the machine.**

## PACKING DETAILS



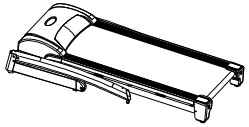
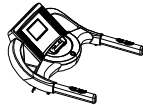

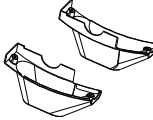

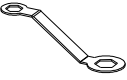

**Warning: Carefully install the product, avoid to make any damage.**

### Notice:

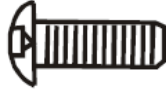
- 1) Carefully read the instructions before installation. Operate in accordance with procedures.
- 2) Check components in the package.
- 3) Remove all paper boxes and foams used as fasteners.
- 4) Check all the following components. If there is missing or problematic parts, please contact the dealer.

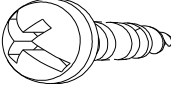
 <p>Frame</p>	 <p>Meter</p>	 <p>Decorating cover at base</p>	 <p>Decorating cover for meter</p>	 <p>Hardware tool bag</p>
--	--	---	--	--

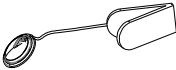
### Hardware tool bag

 <p>Multi-wrench 1 pcs</p>	 <p>Homemade wrench 1 pcs</p>	 <p>Nut 4pcs</p>
 <p>Umbrella-type allen screw M8*20 6pcs</p>	 <p>Umbrella-type allen screw M8*60*15 2pcs</p>	 <p>Umbrella-type cross tapping screw M4.2*15 4pcs</p>
 <p>Washer 8pcs</p>	 <p>Lubricant</p>	 <p>Safety key</p>
 <p>MP3 connector 1pcs</p>	 <p>Umbrella-type allen screw M4*20 4pcs</p>	

## EXPLODED VIEW

These are all the components used in installation. All components are listed in the following form.

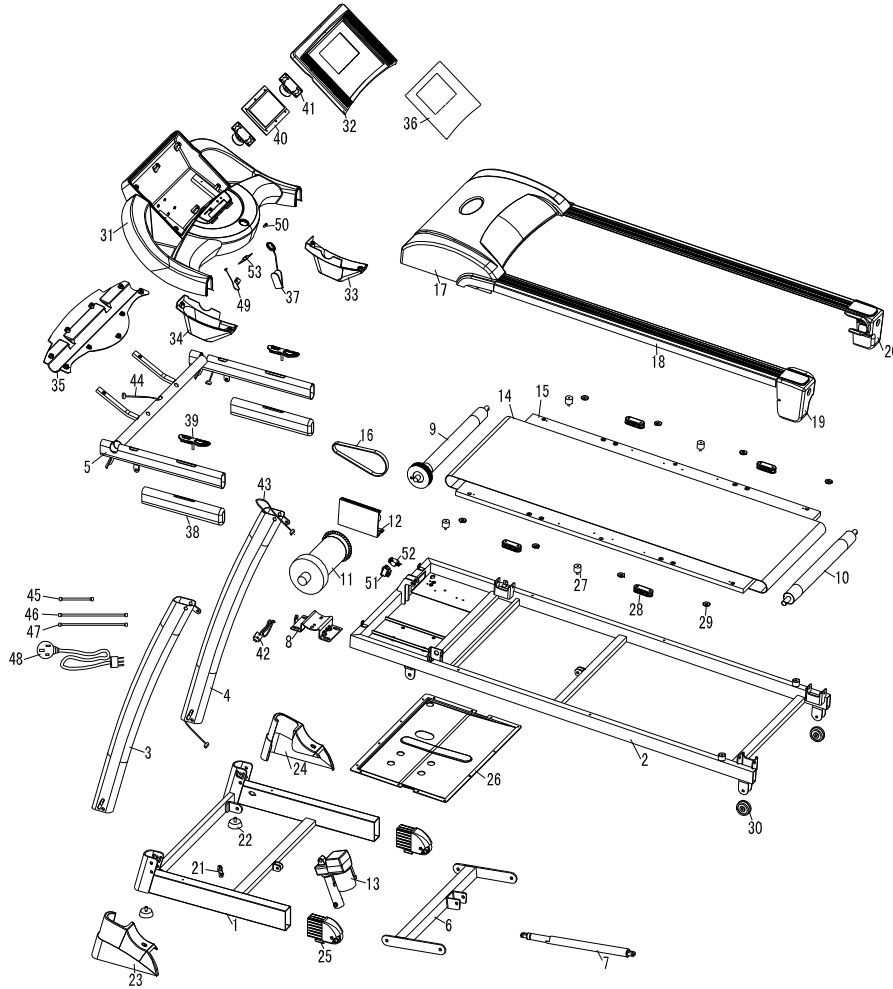

## LIST OF COMPONENTS

No.	Component	Quantity	No.	Component	Quantity
1	Base frame	1	28	Long bumper	4
2	Frame	1	29	Locating pad for decorative bead	8
3	Left pillar accessory	1	30	Rubber wheel	2
4	Right pillar accessory	1	31	Upper cover of meter	1
5	Dashboard frame	1	32	Meter panel	1
6	Incline frame	1	33	Right decorative cover for upright	1
7	Pressure rod	1	34	Left decorative cover for upright	1
8	Motor stator	1	35	Lower cover of meter	1
9	Front roller	1	36	Surface paster	1

10	Back roller	1	37	Safety key	1
11	Motor	1	38	Sponge sheath	2
12	PCB	1	39	Heart rate sensor	2
13	Incline motor	1	40	Upper control board	1
14	Running belt	1	41	Loudspeaker	2
15	Running board	1	42	Photoelectric line	1
16	Multislot belt	1	43	Upper line of communication	1
17	Upper cover of motor	1	44	Lower line of communication	1
18	Decorative bead	2	45	Red connecting line	1
19	Left running belt adjustor	1	46	Red connecting line	1
20	Right running belt adjustor	1	47	Green connecting line	1
21	Safety brace for base frame and frame	1	48	Power connector	1
22	Regulation mat	2	49	Reed pipe for safety key	1
23	Left decorative cover at base	1	50	MP3 module	1
24	Right decorative cover at base	1	51	Power switch	1
25	Base handling wheel set	2	52	Overload protector	1
26	Lower cover of motor	1			
27	Bumper	4			

## TREADMILL STRUCTURE

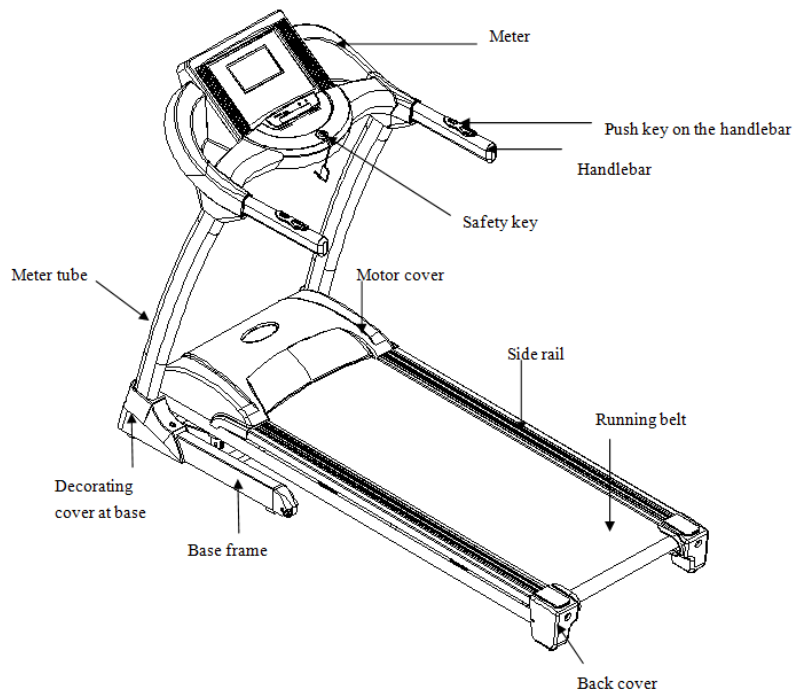

# ASSEMBLY INSTRUCTIONS

## Step 1: Set meter tube on the base frame

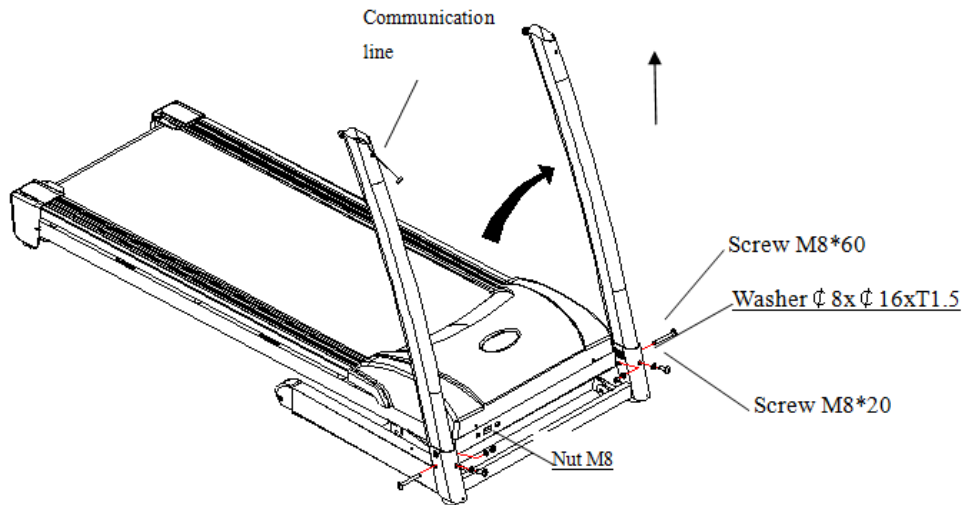

- Make the communication line through the right meter tube.
- Set meter tube on the base frame. Use 2 pcs of Screw M8\*20 with 2 pcs of washer and 2 pcs of Screw M8\*60 with 2 pcs of washer, 2 pcs of nut to solid the meter tube. (Don't fasten screw at first)

## Step 2: Put meter on the meter tube

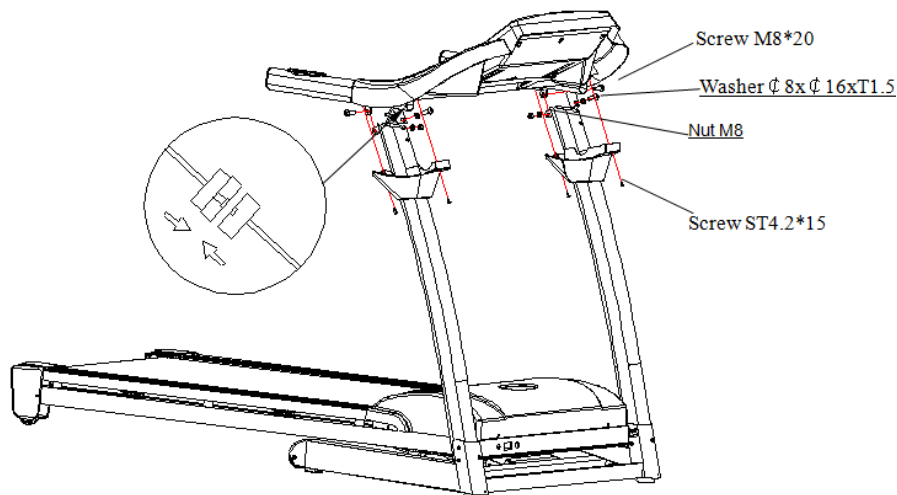

- Put decorating cover for meter on meter tube.
- Make sure that communication lines are connected correctly, in case they are connected in reverse.
- Put meter on the meter tube. Use 4 pcs of Screw M8\*20 with 4 pcs of washer, 2 pcs of nut to solid the meter. (Don't fasten screw at first)
- After the machine is power on, push "Start". If everything goes well, then fasten screws mentioned in front steps.
- Use 4 pcs of Screw ST4.2\*15 to solid decorating cover for meter.

## Step 3: Install decorating cover at base

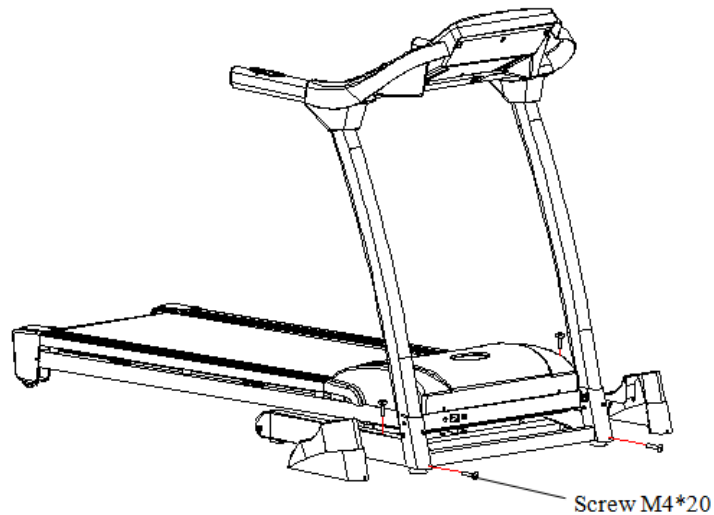

Use 4 pcs of Screw M4\*20 to solid left and right decorating cover at base.

**Step4: Disassemble connecting screw for base frame**

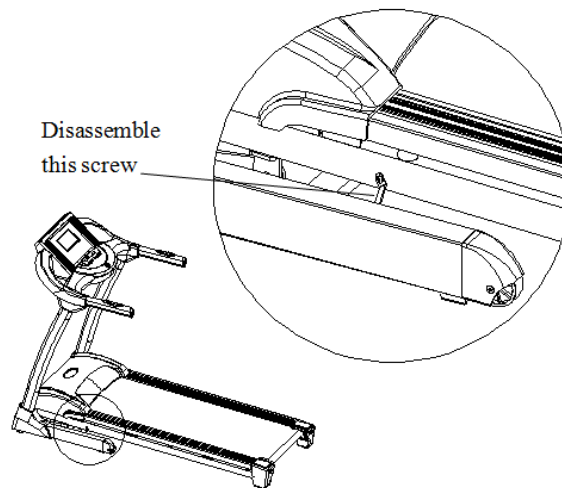

**USAGE**

**POWER SWITCH**

Insert the power plug into the socket and switch on the machine. The switch light will be on and you will hear a voice “Di”. You will find the meter light will also be on.

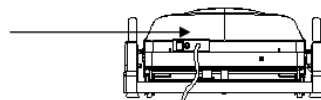

**SAFETY KEY**

The machine can work only when you put safety key at the appointed position. Make sure the other end of the safety key has been nipped to your clothes. In this way, you can pull the safe key for the machine’s sudden stop under the dangerous condition. Then you will not be injured. If you need to reuse the machine, you could put safety key back.





## FOLDING & UNFOLDING

### Folding:

Folding will help to save space.

Before folding, please switch off and pull off the plug.

Use your hand to lift the running board until it has been locked.

### Unfolding:

Step on the supporting tube and pull running board with your hands. The running board will fall to the ground slowly.

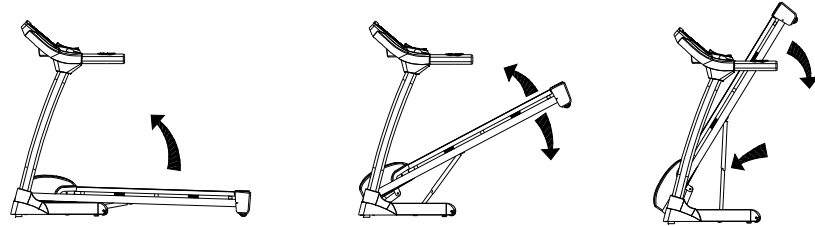



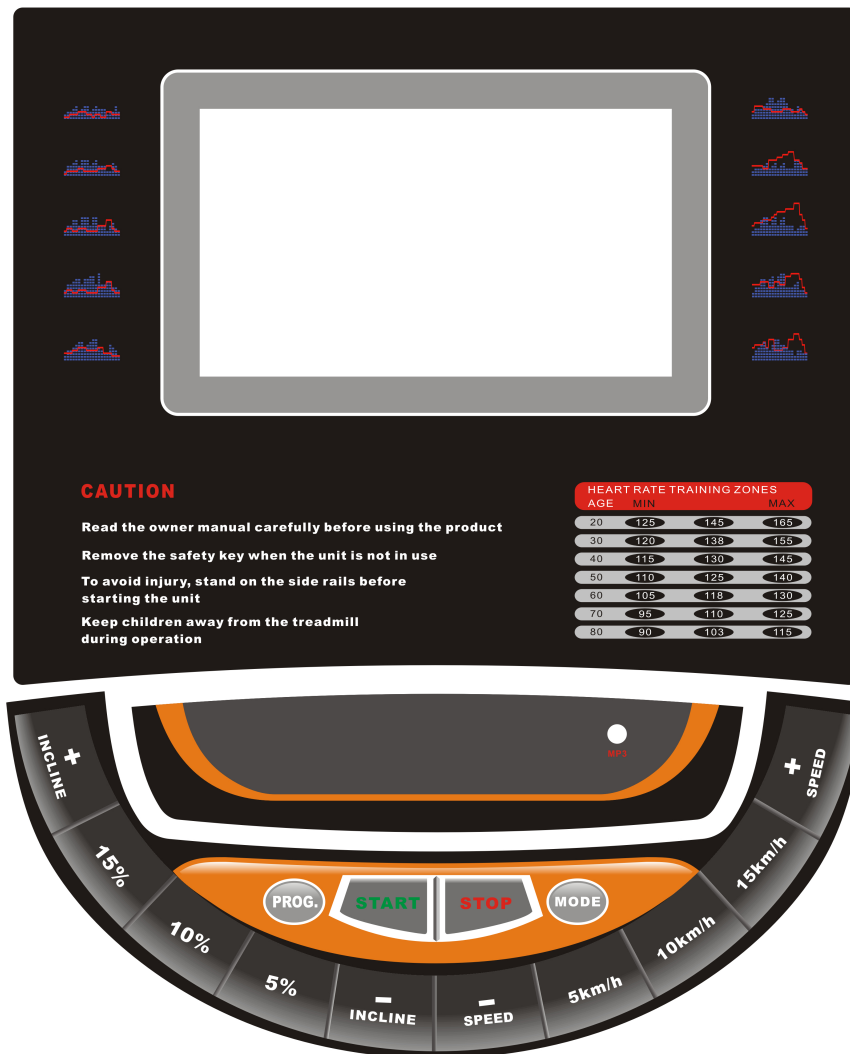



# INSTRUCTION FOR CONSOLE



## TECH INFO

Time		00:00-99:59 Min
Speed		1.0-20.0 km/h
Incline		0-20%
Distance		0.00-99.9 km
Calorie		0-999 KCAL
Heart rate		50-200 / Min
Program	Preset Program	P1-P99
	Body Fat Test	FAT
Sexuality		01/02 (men/women)

## PANEL KEYS

	<p><b>START Key:</b></p> <p>Press "Start" key, there will be 3 seconds countdown displayed on the window! After countdown, the machine will run at the speed of 1.0km/h.</p>
	<p><b>STOP Key:</b></p> <p>Under running condition, press "Stop" key, it will slow down then stop.</p> <p>Reset:</p> <p>Press "Stop" key twice continuously, the machine will be reseted and start for new exercise record when you press "Start".</p>
	<p><b>PROG. Key:</b></p> <p>Under ready condition, press "PROG.", you could select program P1-P99 and FAT.</p> <p>P1-P99 is built-in program, FAT is body fat test.</p> <p>When you finished selecting, you have to press "Start" to start it!</p>
	<p><b>MODE Key:</b></p> <p>Under ready condition, Press "MODE.", you could select 30:00, 1.0 or 50.</p> <p>30:00 is time countdown, 1.0 is distance countdown, 50 is calorie countdown.</p> <p>When you have selected, you have to press "Start" to start it!</p>
	<p><b>SPEED +/- Key:</b></p> <p>Under ready condition, it is used for setting some data. Under running condition, it is used for setting speed, speed difference is 0.1 km/h for each time. When we press it for above 0.5 seconds, it will progressive increase or reduce automatically.</p>
	<p><b>INCLINE <math>\Delta</math> <math>\nabla</math> Key:</b></p> <p>Under ready condition, it is used for setting some data. Under running condition, it is used for setting incline, incline difference is 1% for each press. When we press it for above 0.5 seconds, it will progressive increase or reduce automatically.</p>



**SPEED Direct Key:**

Use these keys, you could set speed for 5km/h, 10km/h, 15km/h directly.



**INCLINE Direct Key:**

Use these keys, you could set incline for 5%, 10%, 15% directly.

**DISPLAYED WINDOW**

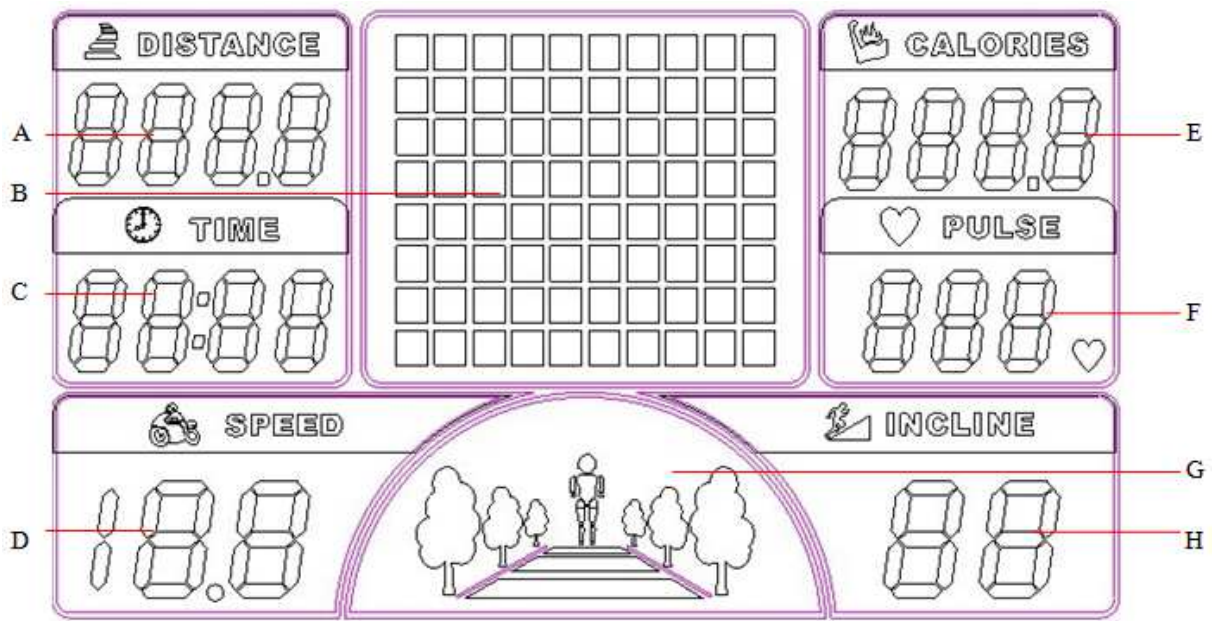

A	Display running distance
B	Display program picture
C	Display running time
D	Display running speed
E	Display calorie
F	Display heart rate
G	Display runway
H	Display specific incline

## DETAILED INSTRUCTIONS

### Quick start (for manual mode)

- Turn on power switch, put safe key in the right position.
- Press “START” key, there will be 3 seconds countdown displayed on the window! After countdown, the machine will run at the speed of 1.0km/h.
- According to your needs, you could use “SPEED+”, “SPEED-” to change speed, use “INCLINEΔ”, “INCLINE▽” to change incline.
- When you put your hands on the handlebar’s heart pulse for 5-8 seconds, it will display heart rate on the screen.

### Manual mode

- Under ready condition, press "Start" key, the machine will run at the speed of 1.0km/h and incline 0%. The other window will forward count from 0. Press “INCLINE direct key”, “SPEED direct key”, “INCLINEΔ”, “INCLINE▽”, “SPEED+”, “SPEED-”, you could change speed and incline.
- Under ready condition, press “MODE” to come into time countdown mode. Window “Time” displays “30:00” and shining, you could press “INCLINEΔ”, “INCLINE▽”, “SPEED+”, “SPEED-” to set exercise time from 5:00-99:00.
- When on distance countdown mode, press “MODE” to enter. Window “DIST” displays “1.0” and shining, you could press “INCLINEΔ”, “INCLINE▽”, “SPEED+”, “SPEED-” to set exercise distance from 0.5-99.9.
- When on calorie countdown mode, press “MODE” to enter. Window “CAL” displays “50” and shining, you could press “INCLINEΔ”, “INCLINE▽”, “SPEED+”, “SPEED-” to set calorie from 10-999.
- After finish setting time, distance or calorie mode, you could press “Start” to start the machine. There will be 3 seconds countdown displayed on the window! After countdown, the machine will run at the speed of 1.0km/h. You could press “INCLINEΔ”, “INCLINE▽”, “SPEED+”, “SPEED-” to adjust speed and incline. Press “Stop”, the machine will stop slowly.

### Built-in Program

There are 99 built-in programs P1-P99. Under ready condition, press “PROG.” Key continuously, Window “PROGRAM” will display “P1-P99”, FAT in turn. P1-P99 are built-in programs. After selecting specific program, press “MODE”, Window “Time” displays “30:00” and shining, you could press “INCLINEΔ”, “INCLINE▽”, “SPEED+”, “SPEED-” to set exercise time from 5:00-99:00. After setting, press “Start” to start the machine. Built-in programs have 16 parts, the time for each part=setting time / 16. When machines come into next part, there will be a voice “Bi-Bi- Bi” to remind you, and speed and incline will be changed according to the built-in programs. No matter whether you have pressed “INCLINEΔ”, “INCLINE▽”, “SPEED+”, “SPEED-” to change speed and incline in front parts. After finishing one program, there will be voice “Bi-Bi- Bi”, the machine stop slowly and “End” will be displayed on the window. 5 seconds later, the machine will come into ready condition.

### Data range:

Parameter	Setting range	Displayed range
Time (minute:second)	5:00-99:00	0:00-99:59
Incline (%)	0-20	0-20
Speed (KM/H)	1.0-20	1.0-20
Distance (KM)	0.5-99.9	0.00-99.9
Heart rate (time/minute)	N/A	60-185
Calorie (cal)	10-999	0-999

### Body fat test

Under ready condition, press “PROG.” key continuously to come into FAT. Press “MODE” key, you could find F-1, F-2, F-3, F-4, F-5 (F-1-- SEG , F- 2-- AGE , F-3-- HEIGHT, F-4-- WEIGHT, F-5-- FAT displayed on the window. Press “INCLINE $\Delta$ ”, “INCLINE $\nabla$ ”, “SPEED+”, “SPEED-” to set. After setting, press “MODE ” to come into “FAT”. At this time, put your hand on the heart pulse for 5-8 seconds, there will be body fat date displayed on the window. You could find whether your weight and height matches. (This data only for reference, can’t be used for medical data)

F-1	Sex	01 Men	02 Women
F-2	Age	10-----99	
F-3	Height	100----200	
F-4	Weight	20-----150	
F-5	FAT	$\leq 19$	Underweight
	FAT	$=(20---25)$	Normal weight
	FAT	$=(25---29)$	Overweight
	FAT	$\geq 30$	Obesity

### Power save mode

Our machine has power save function. When you turn on power switch for 10 minutes and don’t press any key, the machine will come into power save mode and there is no light on the screen. You could press any key into ready condition.

## MAINTENANCE

### RUNNING BELT ADJUSTMENTS

#### Identification ways for the degree of tightness of running belt and poly V-belt.

When the running belt skips, please follow the steps as follows to make sure which belt needs to be adjusted, running belt or poly V-belt.

- a) Unplug all power supply, screw and remove the base cover.
- b) Turn the speed to be around 3km/h, step on the running belt by pressure and try your best to make the running belt stop. If running belt stops, together with the front roll, but the motor still runs, under this condition, it means the poly V-belt needs to be adjusted.
- c) Turn the speed to be around 3km/h, step on the running belt by pressure and try your best to make the running belt stop. If running belt stops, but front roll still runs, under this condition, it means the running belt needs to be adjusted.

#### The adjustment steps for poly V-belt

- a) Unplug all power supply and take off the base cover.
- b) Loosen the four screws for the motor, adjust the V-belt tension bolts in clockwise direction, and then tighten back the four screws for the motor.

#### The adjustment steps for running belt

- a) Turn the speed to be 6km/h. for running

- b) Turn the both tension screws located at the end of the treadmill on the right and left sides, half a turn clockwise using the Allen key. (Diagram 1 and Diagram 2)
- c) After adjustment, running belt still slips; please repeat the steps as above.

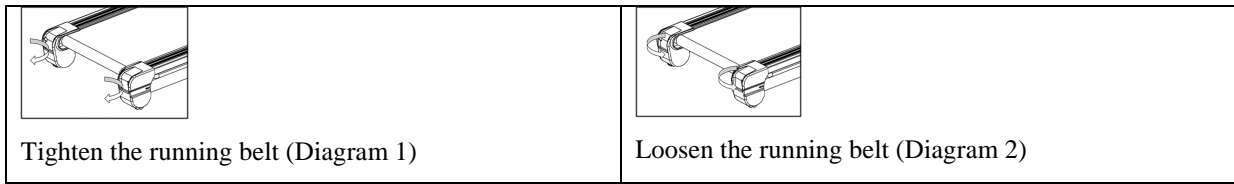

**The adjustment steps for running belt deflection**

The running belt will be deflected more or less under using. Then it needs to be adjusted. The steps are as follows:

- a) Place the treadmill on a horizontal floor, turn the speed to be 6 km/h for running.
- b) If the running belt is deflected to the right, adjust the bolt on the right by turning it for half a turn clockwise, then adjust the bolt on the left by turning it half an anti-clockwise. (See Diagram 3)
- c) If the running belt is deflected to the left, adjust the bolt on the left by turning it for half a turn clockwise, then adjust the bolt on the right by turning it half a turn anti-clockwise. (See Diagram 4)
- d) After the adjustment, the running belt still keeps deflecting, please repeat the steps above.

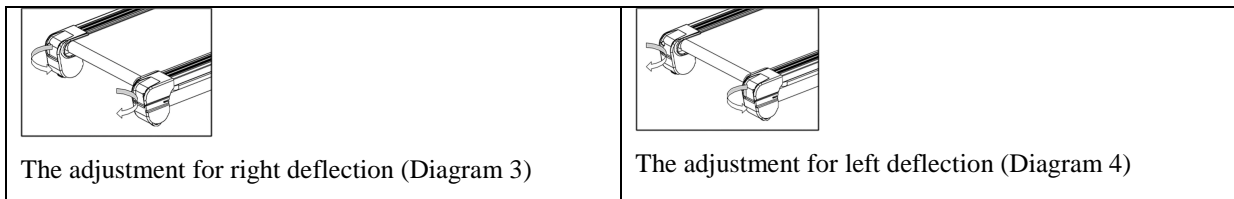

**Running board lubrication- Silicone oil has been provided (White Bottle)**

The treadmill is brand-new and has been pre-factory lubricated. Lubrication is not necessary directly after purchase.

Lubrication needs constant maintenance termly after purchase. The friction between the running board and running belt has a great effect on the treadmills' life. So please lubricate your machine termly (every one month).

The steps are as follows:

**Step 1.** Please unplug power supply for the treadmill and loosen the belt (belt tension screws located at the end of the treadmill).

**Step 2.** After loosening the screws, lift up the running belt and clean in-between the running board. Squeeze the small white bottle of SILICONE oil which was supplied with your purchase and wipe it evenly across the board.

**Step 3.** After lubricating the board, screw the belt tension back to its correct tension. Tighten evenly on both sides. When it is almost tensioned, run the treadmill at 1km without any load. Adjust both tension screws to make the belt in the centre of the back roller. Run the treadmill at 5km for 3mins.

**Step 4.** Stop the treadmill and start to walk on it at 5km/h. Lastly fine tension both screws until it's running smoothly with your weight on.

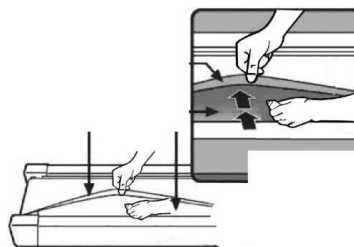

## CLEANING

- a) Please power off and pull the plug out before cleaning.
- b) Wipe out the dust stuck on the surface and running board frequently.
- c) Please clean the surface of frame and running belt with a soft cloth dipped with suds, don't use things like eradicator and naphtha. (After cleaning, please dry it for use)
- d) Please take the protecting cover off every two month, use vacuum dust-collector to suck the dust remaining inside of the protecting cover. (The dust will make the components of circuitry board short circuit)

## CAUTIONS, DEPOSITING

### Cautions

Please make sure that the plug has been pulled out before cleaning or maintenance.

### Depositing

The treadmill should be deposited indoor in case of being damp. Water can't be spattered and nothing can be laid and inserted on the treadmill.

Please keep the air a little humid in winter. And please void the big static electricity, it may disturb the operation of meters or even damage them.

## GUIDES FOR MALFUNCTION

### Analyzing and eliminating malfunction

Item.	Malfunction	Reasons	Solution
1	Treadmill can't be started	The safe key isn't in the right position	Put the safe key in the right position.
		The electrical switch is placed to "0"	Turn the electrical switch to "1".
2	Meter can't display	The meter and upper communication line are not connected well	Disassembly meter and check the upper communication line, make sure that meter and communication line are connected well.
		The upper communication is broken	Replace it!
3	Heart rate can't be displayed	The pole of heart rate sensor is not wet enough	Wet the pole with water or liquor for hard contact lenses.
		Disturbed by electromagnetism	Stay away from electromagnetism.
4	Incline doesn't work	The motor wire is not well connected	Open the motor cover and reconnect it.
5	Running belt runs faster or slower than what has been displayed	Unadjusted	Readjust it.
6	Running belt slips	Running belt is not tight enough	Please read point "Maintenance: The adjustment steps for poly V-belt/running belt" for reference.
7	Running belt is deflected	The running belt is unadjusted	Please read point "Maintenance: The adjustment steps for running



			belt deflection” for reference.
8	Displayed E0 on the screen	Safety key problem	Check the safety key or Reed pipe for safety key.
9	Displayed E01 on the screen	No sensor signal	Check sensor wire, whether it is been connected well or whether it is broken.
10	Displayed E02 on the screen	The PCB problem	Change the PCB.
11	Displayed E03 on the screen	The speed problem	If find it when speed is exceed 8km/h, it is overweight or the broken of running board, running belt. Check the running board and running belt. If it is the problem of running belt, try to add some oil for the running belt at first.
			If speed is not exceed 8km/h, change motor or PCB to check.
12	Displayed E04 on the screen	Communication lines problem	Check the connect of upper communication line with console board and lower communication line with PCB, the connect of upper communication line and lower communication line. If they are connected well, change the communication lines.
13	Displayed E05 on the screen	Over current protection	Check whether it is overloading
			Check whether the drive motor can run normally. If not, replace motor.
			Check PCB, if it is broken, replace PCB.
			Check power voltage, use normal power voltage.
14	Displayed E06 on the screen	The motor problem	Check those in turn: whether the motor wires are connected; change motor; change PCB.
15	Displayed E08 on the screen	Overload protector	If it is not overload, then add oil for running board, change the running belt or running board, change the PCB in turn to check!
16	Displayed E09 on the screen	Overhot protector	Stop the machine and make it to be cold. If it happens when in normal temperature, then replace PCB.
17	Displayed E10 on the screen	Overvoltage protector	Check the voltage, whether it is normal!
18	Displayed E12 on the screen	Incline alarm	Check the VR wire, AC wire, connecting wire of incline motor, incline motor and PCB, whether they are connected well or broken. After checking, restart the PCB.

If you still can't solve the problems after taking the solutions above, we hope that you can contact our dealer or company as soon as possible.

## INSTRUCTION MANUAL FOR IRUNNING+

### 1. Download iRunning to tablet

APP name: [iRunning+] on Google play/iTune Store

### 2. Connect the console to tablet

#### 2.1 iOS system:

Enable Bluetooth function and search device [iRunningXXX] (Note: Please find the device no. from the console). Then perform [Bluetooth pairing device], preset pairing password 0000 (4 zeros).



After pairing, go to desktop and click  to enter APP.

#### 2.2 Android system:



Enter iRunning → Click  to scan device → select device [iRunningXXX]

(Note: Please find the device no. from the console). Then perform [Bluetooth pairing device], preset pairing password 0000 (4 zeros).

### 3. Programs introduction



#### 3.1 Quick Start

Start	Stop	Workout information

Start exercise directly. During exercise, user can adjust Speed\Incline by pressing console buttons (Speed/Incline adjustment as following). After exercise, user can share workout information via Facebook or Twitter or else go back to Homepage.

##### 3.1.1 Incline adjustment drawing:

User may adjust the treadmill incline by pressing UP/DOWN key or hot keys.

Adjust range: 0~15

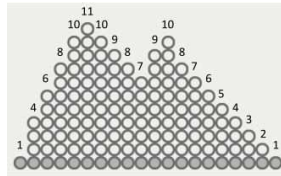

### 3.1.2 Speed adjustment drawing:

User may adjust training speed by pressing UP/DOWN key or hot keys.

Adjust range: 1~18

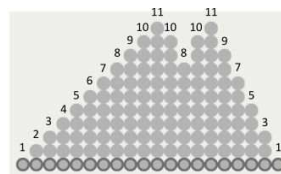

**Warning:** During any exercise, if turn on the safety switch, treadmill will pause immediately and show the Warning page; If turn off the safety switch, system will stop current exercise and go to work-out summary page.

Warning page:



### 3.2 Program

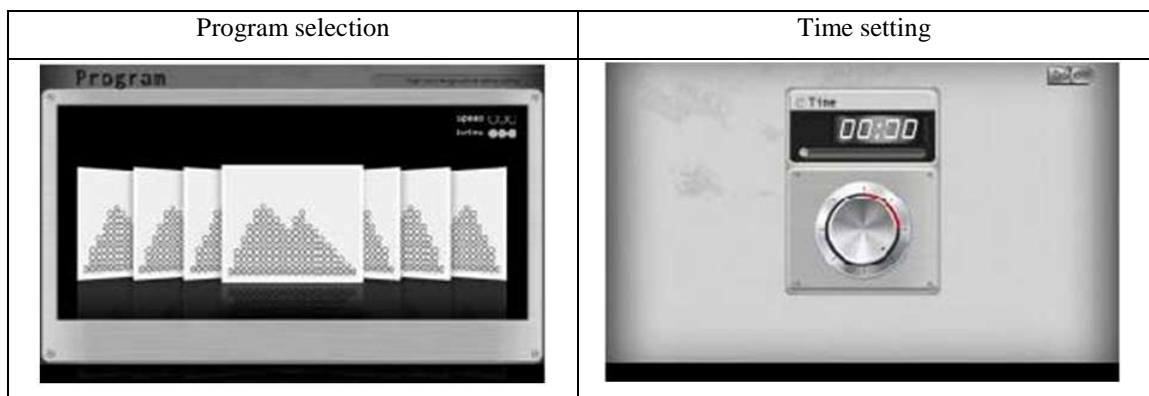

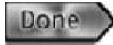
User can select from P1 to P20 for training. After selection, set training time and press  to start. During exercise, user can adjust Speed\Incline by p pressing console buttons. After exercise, user can share workout information via Facebook or Twitter or else go back to Homepage.



### 3.3 Manual

Setting page:

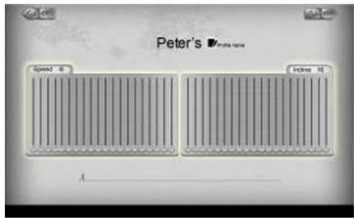
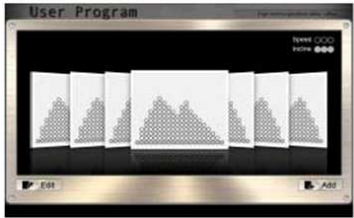

User can set target Time/Distance/Calories by manual. After setting, press **Done** to start. During exercise, user can adjust Speed/Incline by pressing console buttons. After exercise, user can share workout information with Facebook or Twitter or else go back to Homepage.

### 3.4 User Program

Setting page	Program cluster	Time setting
		

User can design his/her own training graph by adjusting Speed/Incline value and then name the program for future reference. From the program cluster, user may add or delete program. When entering program, set time and press start. During exercise, user can an adjust Speed/Incline by pressing console buttons. After exercise, user can share workout information with Facebook or Twitter or else go back to Homepage.

### 3.5 HRC

HR selecting	Custom HR Setting	Exercise page
		

In this mode, user can choose: 55%, 65%, 75%, custom for different heart rate training. For example, user chooses 55%, system will self-calculate Heart Rate:  $(220 - \text{Age}) * 55\% = 103.4 \text{ BPM}$ . After selection, double click the icon to enter to enter the program. Then set time and press **Done** to start. By pressing Custom, user can set target HR. System max.BPM is 230. When Time counts down to 0 from set value, console will stop and treadmill stop as well, then comes to workout page.

## Warm up Reminder



When exercise start, there is 2 minutes Warm up time. If no hand pulse input, system will alarm and remind user to grip handlebar. Without pulse input for 30 seconds, console will stop.

## 4. Personal Setting

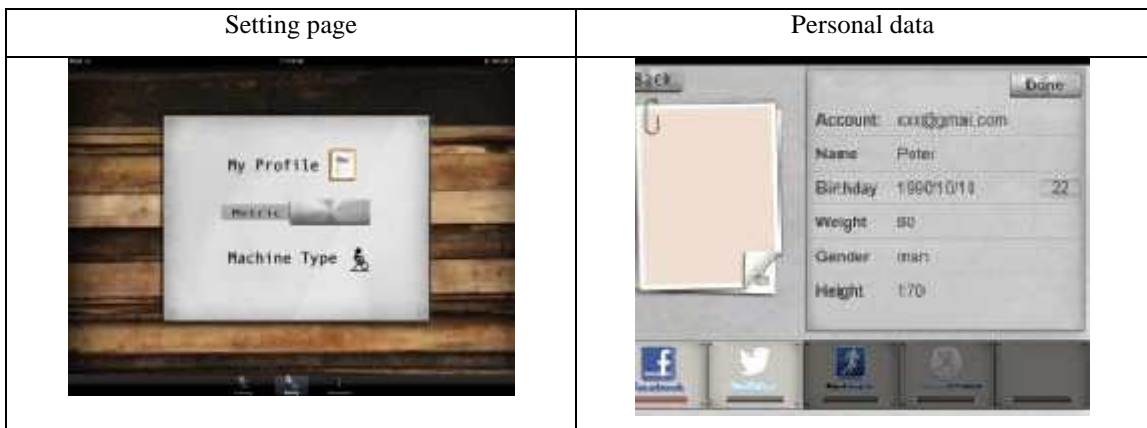

User may set personal profile by entering [Setting] and select Metric or Imperial. After setting personal data, it can be saved for future reference.

## 5. Workout Information

History record:





From the Information center, user can review history workout record.

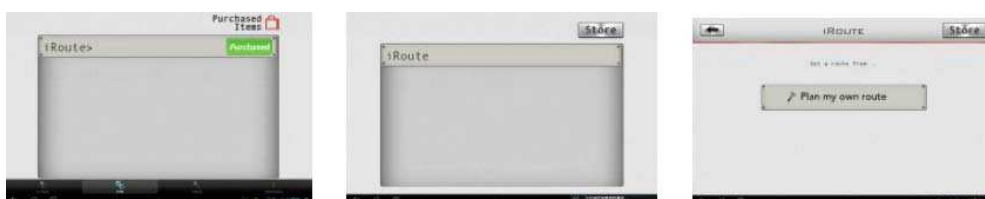

## 6. GYM Center – i-Route

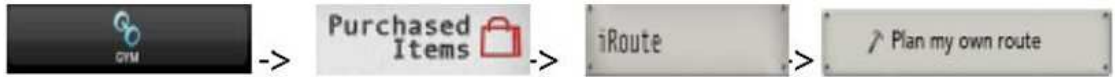

Select

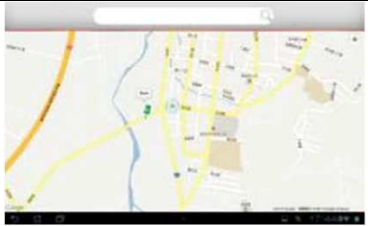
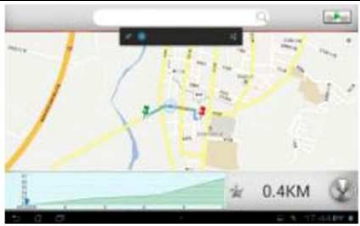

to plan training route. Set Start location by first long press and End location by second long press. After planning the route, press  to start training.

Start location	End location	Training page
		

During exercise, user may click  to choose monitor routes by Map view/Satellite view/Street view mode.

<p>Map view</p> 	<p>Satellite view</p> 
<p>Street view</p> 	

i-Route multiple turning points:



Method: Firstly set Start and End location. Then get the first turning point by one click. You can totally set 8 turning points. System will plan the route again after your setting.

## **7. APP Supported Devices**

### 7.1 Supported mobile devices:

- Android: 1280\*752 Android 4.0 tablet (only for 10 inch above)
- i-OS: 5.0 or above, iPad4, iPad3, iPad2, iPad, iPad Mini

### 7.2 Work with machine type: SD8710 console and treadmill

## **TERMS AND CONDITIONS OF WARRANTY, WARRANTY CLAIMS**

### **General Conditions of Warranty and Definition of Terms**

All Warranty Conditions stated hereunder determine Warranty Coverage and Warranty Claim Procedure. Conditions of Warranty and Warranty Claims are governed by Act No. 40/1964 Coll. Civil Code, Act No. 513/1991 Coll., Commercial Code, and Act No. 634/1992 Coll., Consumer Protection Act, as amended, also in cases that are not specified by these Warranty rules.

The seller is SEVEN SPORT s.r.o. with its registered office in Borivojova Street 35/878, Prague 13000, Company Registration Number: 26847264, registered in the Trade Register at Regional Court in Prague, Section C, Insert No. 116888.

According to valid legal regulations it depends whether the Buyer is the End Customer or not.

“The Buyer who is the End Customer” or simply the “End Customer” is the legal entity that does not conclude and execute the Contract in order to run or promote his own trade or business activities.

“The Buyer who is not the End Customer” is a Businessman that buys Goods or uses services for the purpose of using the Goods or services for his own business activities. The Buyer conforms to the General Purchase Agreement and business conditions to the extent specified in the Commercial Code.

These Conditions of Warranty and Warranty Claims are an integral part of every Purchase Agreement made between the Seller and the Buyer. All Warranty Conditions are valid and binding, unless otherwise specified in the Purchase Agreement, in the Amendment to this Contract or in another written agreement.

### **Warranty Conditions**

#### Warranty Period

The Seller provides the Buyer a 24 months Warranty for Goods Quality, unless otherwise specified in the Certificate of Warranty, Invoice, Bill of Delivery or other documents related to the Goods. The legal warranty period provided to the Consumer is not affected.

By the Warranty for Goods Quality, the Seller guarantees that the delivered Goods shall be, for a certain period of time, suitable for regular or contracted use, and that the Goods shall maintain its regular or contracted features.

#### **The Warranty does not cover defects resulting from:**

User's fault, i.e. product damage caused by unqualified repair work, improper assembly, insufficient insertion of seat post into frame, insufficient tightening of pedals and cranks

Improper maintenance

Mechanical damages

Regular use (e.g. wearing out of rubber and plastic parts, joints etc.)

Unavoidable event, natural disaster

Adjustments made by unqualified person

Improper maintenance, improper placement, damages caused by low or high temperature, water, inappropriate pressure, shocks, intentional changes in design or construction etc.

### **Warranty Claim Procedure**



The Buyer is obliged to check the Goods delivered by the Seller immediately after taking the responsibility for the Goods and its damages, i.e. immediately after its delivery. The Buyer must check the Goods so that he discovers all the defects that can be discovered by such check.

When making a Warranty Claim the Buyer is obliged, on request of the Seller, to prove the purchase and validity of the claim by the Invoice or Bill of Delivery that includes the product's serial number, or eventually by the documents without the serial number. If the Buyer does not prove the validity of the Warranty Claim by these documents, the Seller has the right to reject the Warranty Claim.

If the Buyer gives notice of a defect that is not covered by the Warranty (e.g. in the case that the Warranty Conditions were not fulfilled or in the case of reporting the defect by mistake etc.), the Seller is eligible to require a compensation for all the costs arising from the repair. The cost shall be calculated according to the valid price list of services and transport costs.

If the Seller finds out (by testing) that the product is not damaged, the Warranty Claim is not accepted. The Seller reserves the right to claim a compensation for costs arising from the false Warranty Claim.

In case the Buyer makes a claim about the Goods that is legally covered by the Warranty provided by the Seller, the Seller shall fix the reported defects by means of repair or by the exchange of the damaged part or product for a new one. Based on the agreement of the Buyer, the Seller has the right to exchange the defected Goods for a fully compatible Goods of the same or better technical characteristics. The Seller is entitled to choose the form of the Warranty Claim Procedures described in this paragraph.

The Seller shall settle the Warranty Claim within 30 days after the delivery of the defective Goods, unless a longer period has been agreed upon. The day when the repaired or exchanged Goods is handed over to the Buyer is considered to be the day of the Warranty Claim settlement. When the Seller is not able to settle the Warranty Claim within the agreed period due to the specific nature of the Goods defect, he and the Buyer shall make an agreement about an alternative solution. In case such agreement is not made, the Seller is obliged to provide the Buyer with a financial compensation in the form of a refund.



**SEVEN SPORT, s.r.o.**

Borivojova 35/878 130 00 Praha 3, Czech Republic IČO: 268 47 264, DIČ: CZ26847264

Orders: +420 556 300 970, objednavky@insportline.cz

Warranty Claims: +420 556 770 190, Mobile: +420 604 853 019, reklamace@insportline.cz

Service: +420 556 770 190, Mobile: +420 604 853 019, servis@insportline.cz

Fax: +420 556 770 192, (Service +420 556 770 191)

Web: www.insportline.cz, www.worker.cz, www.worker-moto.cz



**INSPORTLINE, s.r.o.**

Električná 6471, 911 01 Trenčín, Slovakia IČO: 36311723, DIČ: SK2020177082

Orders: +421(0)326 526 701, +421(0)917 700 098, objednavky@insportline.sk

Warranty Claims: +421(0)326 526 701, +421(0)918 408 519, reklamacie@insportline.sk

Fax: +421(0)326 526 705

Web: www.insportline.sk, www.worker.sk, www.worker-moto.sk

Date of Sale:

Stamp and Signature of Seller: